



# Height Safety Equipment User Manual





<b>General Warnings</b>	<b>4</b>	<b>Anchors</b>	<b>21</b>
User Competency	4	Rigid Anchors	21
Limitations	4	3500 Series Anchor Straps and Black Snake	21
Attachment	4	<b>Horizontal Lifelines</b>	<b>22-23</b>
Single Use Only	4	3400 Series	22
Chemicals	4	Anchorage Attachments Required	22
Maintenance	4	Recommended Rigging Method	23
<b>Risk Control</b>	<b>5</b>	3400UK – Two Man System	23
Eliminate the Risk	5	Line Deflection Allowances	23
Substitute the Risk	5	<b>Horizontal Lifeline Tensioner</b>	
Isolate the Risk	5	<b>Instructions</b>	<b>24-25</b>
Engineering Controls	5	<b>3108 Series</b>	<b>26</b>
Administration Controls	5	Adjustable Rope Anchorages	26
Personal Protective Clothing and Equipment (PPE)	5	<b>3109 Series</b>	<b>27</b>
<b>Fall Protection Categories</b>	<b>6</b>	Vertical Fall Arrest Lines	
Work Restraint	6	(Type 1 Fall Arrest Device)	27
Work Positioning	6	<b>Suspension Trauma</b>	<b>28-29</b>
Fall Arrest	6	Use of SG238 Suspension Trauma Relief Straps	29
<b>Fall Clearance Allowances</b>	<b>7</b>	<b>4006 – Confined Space Spreader Bar</b>	<b>30</b>
<b>Types of Attachment Points</b>	<b>8-9</b>	<b>FPV8020 – Bosuns Chair</b>	<b>30</b>
<b>Fitting Instructions</b>	<b>10-11</b>	<b>Training</b>	<b>31-32</b>
Vest Style Harnesses	10	How It Works	31
Step in Style Harnesses	11	Certification	31
<b>Buckle Connection Instructions</b>	<b>12-13</b>	Height Safety Training	31
2 Bar and 3 Bar Buckles	12	Rescue Training	31
Quick Connect Buckles	12	SpanSet Training Courses	32
Slotted Buckles	12	<b>General Maintenance</b>	<b>33-34</b>
Dorsal Extension	13	Checklist for Inspection of Harnesses	
<b>Types of Harnesses</b>		and Pole Straps	33
<b>and Environmental Conditions</b>	<b>14</b>	Inspecting iWeb Enabled Products	33
<b>Types of Lanyards</b>	<b>15</b>	Checklist for Inspection of Lanyards	34
<b>Energy Absorbing Lanyard Warnings</b>	<b>16</b>	Inspecting iWeb Enabled Products	34
<b>2700 Series Pole Straps</b>	<b>17</b>	Washing Instructions	34
<b>Types of Connectors</b>	<b>18</b>	<b>Fall Protection Equipment Log</b>	<b>35</b>
<b>Connector Instructions</b>	<b>19</b>		
<b>Anchorage</b>	<b>20</b>		
Selecting an Anchor Point	20		
Anchor Straps	20		
Load Table for Anchorages	20		

# General Warnings

## User Competency

### **This is life saving equipment!**

Users of this equipment must be competent to do so. All operators must be trained in the selection, use and maintenance of this equipment. SpanSet Australia offer nationally accredited courses in Working Safely at Height and various rescue modules which are detailed at the back of this manual.

**SpanSet Australia Ltd accepts no responsibility or implied warranty should the product be found to be misused or applied in other than its intended purpose. Refer to AS/NZ 1891.4 for further guidance.**

## Limitations

Each attachment must only be used for its labelled purpose. No alterations or additions are permitted to be made to this product, doing so will void all warranty and liability. All harnesses come standard with front and rear fall arrest attachments. While both front and rear are tested to the same criteria, SpanSet Australia Ltd advises that for free fall arrest the rear D is the preferred attachment point. The front fall arrest attachment is best suited to ladder systems and limited fall applications.

## Attachment

When securing a harness via a lanyard to an anchorage point the connection should be at a level which will result in minimum free fall and the least total fall distance consistent with the wearers ability to carry out work tasks.

Where making a connection to a point on a harness that cannot be seen by the wearer, either the connection should be made prior to donning the harness, or the connection should be made or checked for security by a second person.

## Single Use Only

These products are to be discarded if a fall has been sustained. Lanyards with energy absorbers must be discarded if any deformation or destructive action has taken place.

## Chemicals

If any part of the product is exposed to chemicals, the user should consult SpanSet Australia to determine whether it is suitable for continued use.

**Note:** labelling or writing an operators name with a marker pen does not constitute chemical contamination on SpanSet products.

## Maintenance

All harnesses and lanyards must be inspected by a competent person at least every six months, or more frequently if environmental conditions demand. If not deemed to be suitable for continued use, they must be removed from service. SpanSet Australia offers nationally accredited competent person training. Refer to AS/NZ 1891.4 for further guidance.

# Risk Control

Controlling the risks is the next step after hazard identification and risk assessment. The following steps identify the hierarchy of risk control management:

## **Eliminate the Risk**

Remove the risk from the workplace altogether. Wherever possible, this should be the first option used.

- Work from ground level wherever possible: i.e. use paint rollers with extendable handles rather than ladders.
- Prefabricate wall frames horizontally before standing them up.

## **Substitute the Risk**

Substitute the risk with a less hazardous one. This is the second preferred control solution.

- Use a scaffold or elevating work platform to work at heights in place of a ladder.

## **Isolate the Risk**

Isolate or separate the hazard or hazardous work practices from people not involved in the work or the general work areas.

- Mark off hazardous areas
- Install screens or barriers.

## **Engineering Controls**

When elimination or substitution of a risk is not an option then the preferred solution is engineering controls. For example:

- Walkways
- Permanent Handrails
- Fixed Static Lines
- Fixed Ladders
- Cages
- Permanent Anchor Points.

## **Administration Controls**

Introduce work practices that reduce the risk. For example:

- Exclusion Zones
- Warning Signs
- Provide training on the hazard
- Reduce the number of employees exposed to the hazard
- Introduce lock-out procedure.

## **Personal Protective Clothing and Equipment (PPE)**

It is important that PPE is viewed as the last preferred solution for risk control. Efforts regarding the removal of risks to safety and health, while using PPE, should still continue by means and order of:

- Elimination
- Substitution
- Isolation
- Engineering
- Introduce lock-out procedure
- PPE.

# Fall Protection Categories



## Work Restraint (Restraint Technique)

Work restraint is the preferred approach to fall protection - it prevents you from falling and from suffering possible injury from the fall arrest system. Work restraint is a technique which uses PPE to prevent a person from entering an area where a risk of fall from height exists.



## Work Positioning

Work positioning is a technique for supporting a person while working by means of PPE in tension, in such a way as to prevent a fall.



## Fall Arrest

Fall arrest is an approach which makes use of items of PPE to stop a falling person under safe conditions. This means that if a worker is in a position such that if they lose control they will fall, they are required to use PPE to limit both the distance and force of that fall.

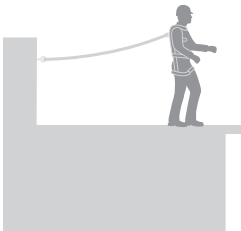

Total restraint



Restrained fall

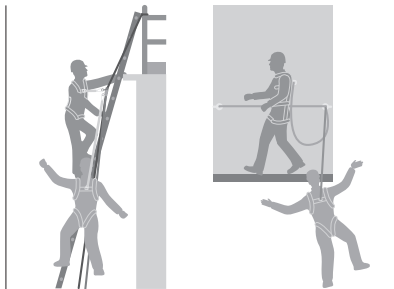

Limited free fall

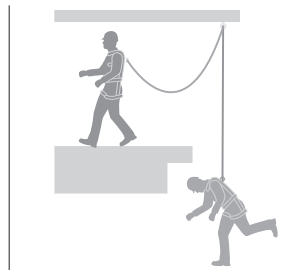

Free fall arrest

# Fall Clearance Allowances

## ERGO 1.8m Lanyard

Minimum Weight @ 50kg - 5.1 Minimum Fall Clearance

Maximum Weight @ 100kg - 5.76 Minimum Fall Clearance

## ERGOplus 1.8m Lanyard

Minimum Weight @ 60kg - 5.17 Minimum Fall Clearance

Maximum Weight @ 140kg - 6.5 Minimum Fall Clearance

## Maximum Allowable Free Fall – 2.0m

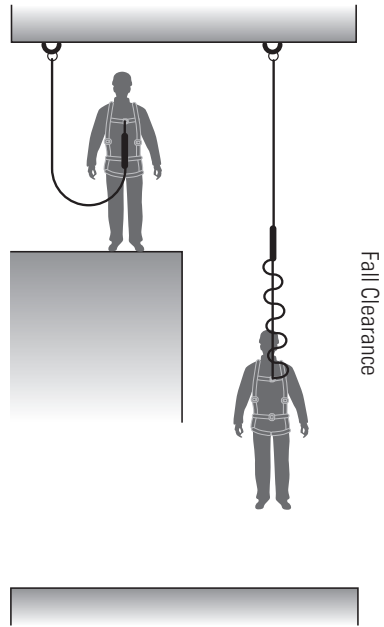

\* Generic chart for illustration. Refer to product specific data.

## Maximum User Weights

SpanSet harnesses are rated in excess of 150kg. SpanSet energy absorbing lanyards are rated to 140kg.

Maximum User Weight	Inertia Reels and Winches		
	Saverline SVLB-2 SVLB-3 2m and 3m Inertia Reels	IKAR Saverline Range	SVLWB-45 SVLWB-60 45m and 60m Personnel Winches
150kg	136kg	150kg	

# Types of Attachment Points



- 1 Confined space attachment loops**  
Reverse folded loops to eliminate snagging and minimise metal components in contact with the body. Both loops must be used together.

- 2 Front fall arrest D ring**  
For versatility and ease of rescue.

- 3 Pole strap attachment D rings**  
Easy to locate and connect to.

- 4 Rear fall arrest D ring**  
Easy to locate and connect.



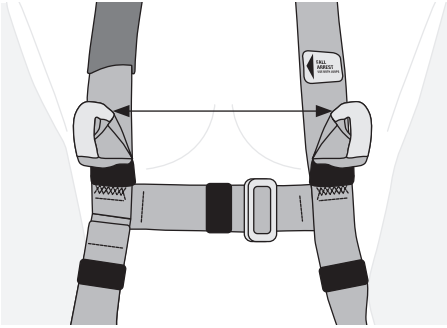

**Front Fall Arrest Loops**  
 (Both loops must be used together)

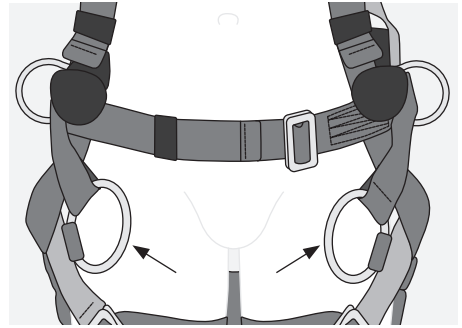

**Auxiliary Pole Strap Rings**  
 (Both Ds must be used)

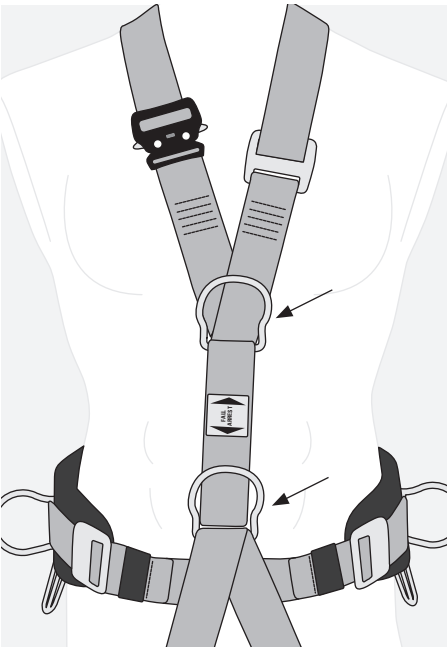

**Front Fall Arrest**  
 Attachments (can also be used for abseiling,  
 work positioning or belay work)

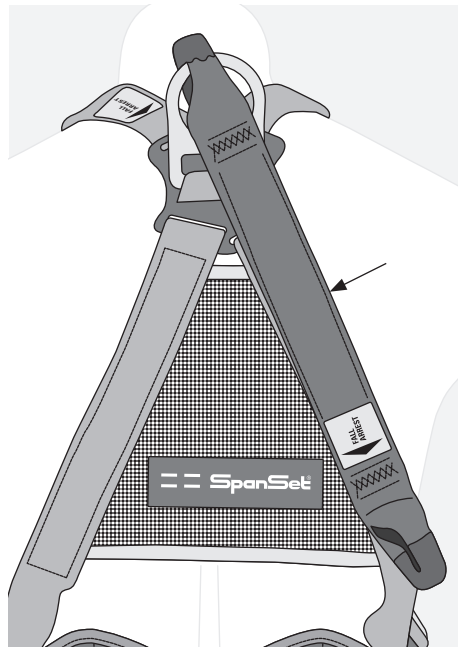

**Dorsal/Rear (Fall Arrest)**  
**Extension Strap**

**WARNING: ONLY USE ATTACHMENTS THAT ARE SPECIFICALLY LABELLED FOR THE APPLICATION**

# Fitting Instructions

## Vest Style Harnesses



Hold harness by the Rear D with all straps undone



Place both shoulder straps over the shoulder as in donning a vest



Connect chest buckle, ensuring that green spot is seen in the receiver window. Tighten strap.



If a waist belt is fitted, connect and tighten



Connect leg buckle



Tighten leg strap



Connect opposite leg strap



Tighten straps and retain free webbing within the elastic web tidy



Fitted harness should be snug and firmly fitted, particularly the leg straps

## Step-in Style Harnesses

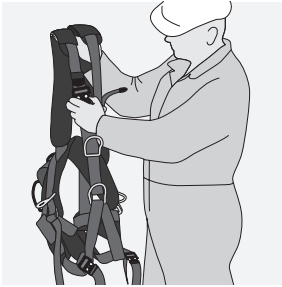

Hold harness by the shoulder straps and disconnect the chest fast release buckle



Place left leg through the left leg strap

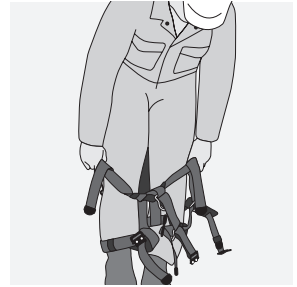

Place the right leg through the right leg strap



Pull the harness upwards to waist level

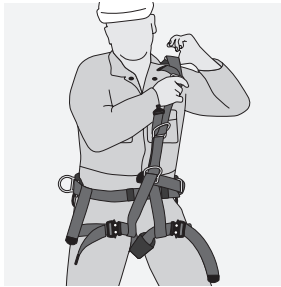

Place the left shoulder strap over the shoulder



Repeat for right shoulder strap and connect the buckle. Ensure green spot can be seen in the receiver window



Tighten waist strap by pulling both sides



Tighten leg straps

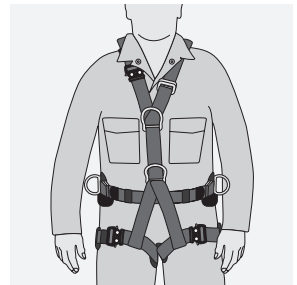

Fitted harness should be snug and firmly fitted, particularly the leg straps

# Buckle Connection Instructions

## 2-3 Bar Buckles

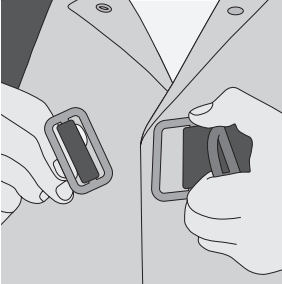

Bring the 2 buckles together, ensuring there are no twists in the webbing

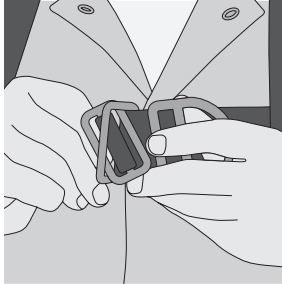

Turn the 3 bar buckle and push it through the 2 bar buckle

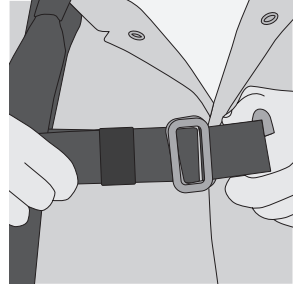

Ensure both buckles lay flat against one another and tension the strap

## Quick Connect Buckles

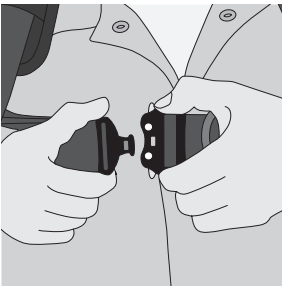

Align the tongue with the slot in the receptor buckle and insert

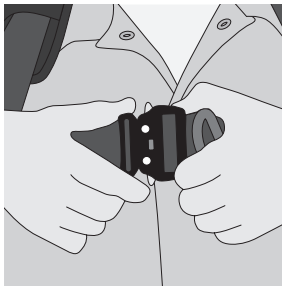

Push together until you hear a distinct click and the green mark appears in receiver window

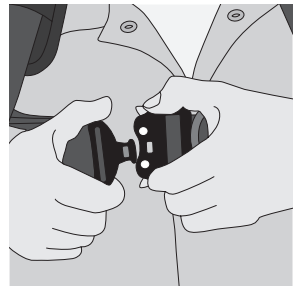

To release, push the two side tabs simultaneously and separate the buckles

## Slotted Buckles

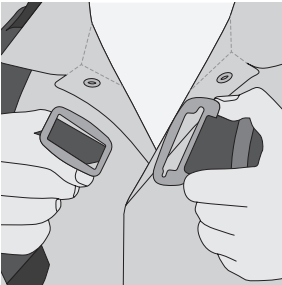

Bring the 2 buckles together, ensuring there are no twists in the webbing

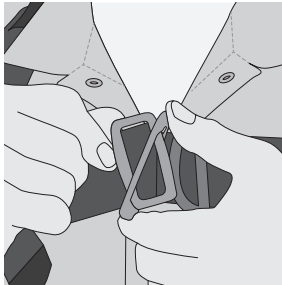

Push the smaller buckle through the slot in the larger buckle

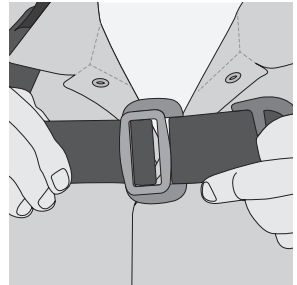

Ensure both buckles lay flat against one another and tension the strap

## Dorsal Extension

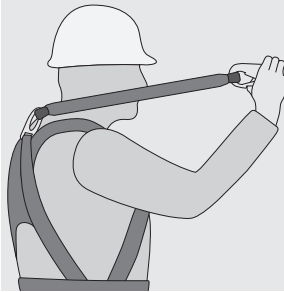

The dorsal extension is located at the rear of the harness, held in place by velcro strip



Remove dorsal extension from velcro strip and bring under the armpit

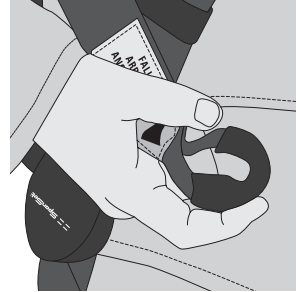

Ensure the eye is open to receive the connection hardware

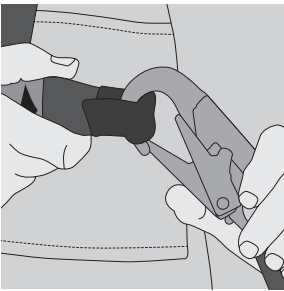

Connect attachment hardware to the eye, making a visual check for secure connection

**Note:** All SpanSet dorsal extensions are deliberately located on the rear of the harness in order to keep an attached lanyard away from the neck and face.

The harness is correctly fitted (donned) when:

- The dorsal D ring (rear) is between the shoulder blades
- The shoulder straps are firm
- The chest strap is firm and located mid-chest
- The leg straps are firm
- There are no twists in any straps
- The butt strap is located just below the buttocks
- Spare strap ends are tucked away.

**Note:** When calculating fall clearance ensure that the length of the dorsal extension has been added to the lanyard length.

# Types of Harnesses and Environmental Conditions

## **ERGOplus and ERGOiplus Harnesses**

These premium harnesses are padded for comfort and feature quick connect buckles for convenience when donning. For professional users in dry conditions where no excessive dirt, mud and grime build up is experienced. ERGOiplus also features iWeb inspectable webbing.

## **ERGO Harnesses**

These are the workhorses in the range and are best suited for dirty and harsh conditions by professional operators who appreciate no nonsense reliability. They feature the most reliable buckle system, being the 2 and 3 bar buckle, and don't feature any moving parts or unnecessary padding.

## **Compliance Harnesses**

Tradie and EWP (also known as Spectre) harness are compliant entry level harnesses without many of the features of the previous harness ranges such as confined space loops, front D and suspension trauma straps

## **HotWorks Harnesses**

These harnesses are for use around welding, grinding and similar hot work. They are made from heat resistant materials including the padding and have a lower total cost of ownership compared to polyester harnesses which are susceptible to heat.

## **WaterWorks Harnesses**

These are for use around constantly wet areas and confined spaces and utilise all stainless steel fittings for longevity.

## **Belts**

Waist belts on their own must not be used for fall arrest applications. SpanSet generally only manufacture miners' belts, to carry battery packs and self-rescuer devices. These belts may be integrated into full body harnesses however only the load bearing and tested harness attachment points listed in AS/NZS 1891.1 may be utilised in fall, rescue or suspension applications.

## **Maximum User Weights**

Please refer to particular product specifications for maximum user weight.

# Types of Lanyards

## **Webbing Lanyards (ERGO)**

These are the most cost effective and feature lightweight polyester 29kN webbing integrated with a tear web energy absorber with steel hardware

## **Webbing Lanyards (ERGOplus)**

Feature iWeb inspectable webbing including aluminium hooks and karabiners with ANSI high strength gates.

## **Adjustable Lanyards**

These are commonly used in EWPs and in areas where limiting the free fall distance is desirable. Less fall distance = less force on the body.

## **Elastic Lanyards**

These are ideal for preventing snagging and tripping as the slack remains taught. Commonly used in EWPs and climbing applications.

## **HotWorks Lanyards**

For use around welding and grinding applications where the sparks generated would normally melt polyester webbing

## **Rope Lanyards**

Serve the same function as a webbing lanyard. Using rescue standard rope means the outer sheath is a contrasting colour to the inner load bearing core, making inspection easier.

## **Energy Absorbers**

All fall arrest lanyards have integrated energy absorbers. Stand alone energy absorbers are available for use with adjustable rope grabs and on fall arrest anchorages lines of extended length

## **Twin Webbing and Rope Lanyards**

These are used to maintain a continuous connection when passing from one structure or anchorage to another. Commonly used in climbing and transversing applications

## **Wire Rope Lanyards**

PVC coated wire leg used to prevent contamination from paint and chemicals or offer resistance to heat. Note: the energy absorber component is not protected from heat

## **Back Hooking Lanyards**

Allows back hooking or “choking” around beams and structures. Fitted with a wear sleeve for abrasion resistance, and a reinforced hook to resist side loading. Do not back hook with a lanyard unless it is specifically designed to do so.

## **Maximum User Weights**

SpanSet energy absorbing lanyards are rated to 100kg (ERGO iPlus and Plus range to 140kg). Specialised lanyards to higher weights are available on request.

**All SpanSet energy absorbing lanyards are manufactured to AS1891.5. They reduce the forces experienced in an arrested fall to under 6kN (approximately 600kg).**

# Energy Absorbing Lanyard Warnings

- Connection between the harness and anchor system is usually made via a fall arrest lanyard or device
- Maximum allowable free fall is 2m
- These are fixed or adjustable length lanyards normally manufactured from rope or polyester webbing, and include an in-line personal energy absorber, which limits the force on the body to less than 6kN
- The shock absorbing end of the lanyard should always be attached to the harness. Never choke (back-hook) the lanyard end around the anchor **unless the lanyard is specifically design to do so**; this will weaken the lanyard and in the event of a fall could cause it to fail, or result in the snap hook bending over an edge and/or accidentally rolling open
- It is critical that the worker checks for adequate ground/nearest level clearance prior to using an energy absorbing lanyard
- Energy absorbers do not start operating (or tear out) below 2kN (200kg)
- Do not use the lanyard as a pole strap
- The lanyard must be destroyed if a fall has occurred, where the shock absorber has been deployed
- The lanyard must be destroyed if the 10 year life has expired (See Remove from Service Date)
- Lanyards should be inspected before use and externally by a competent person every 6 months
- When using a shock absorber in conjunction with a twin tail lanyard, the tail end not in use should either be attached to the stowage point supplied on the lanyard or be clipped alongside its partner on the anchor point so as not to inhibit the tear out function of the energy absorber. Only the shock absorbing end should be connected to the harness - **the free or tail end must not be attached to the harness!** Failure to observe this may isolate the energy absorber and cause excessive forces on the body of the user
- Never substitute a twin tail lanyard with two single lanyards; two single shock absorbers will not tear out sufficiently in the event of a fall and may result in excessive shock loading to the user
- Avoid wrapping or looping the lanyard around or over sharp edges
- Check that your weight including tools and equipment is inside the weight range of the lanyard.

For requirements on selection, use, maintenance and training consult with AS/NZ 1891.4.



## 2700 Series Pole Straps

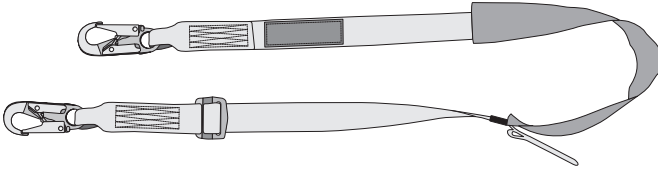

2700 with webbing wear sleeve

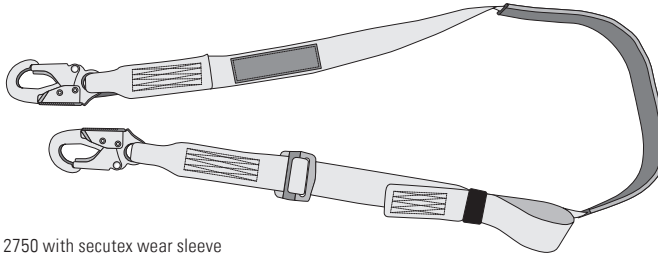

2750 with secutex wear sleeve

A pole strap is suitable for work positioning when attached to the side Ds of a full body harness

- Connect the pole strap via the safety hooks to the side D rings with the locking gates furthest from the body
- Ensure both sides are securely connected before applying load to the strap
- Use the tensioner buckle to adjust the length of the strap
- Always ensure the strap is in tension and not slack
- Beware of sharp edges and pinch points to avoid damage to the main strap
- Ensure the protective wear sleeve is in place on the strap
- For steel and abrasive contact always use a pole strap with secutex wear sleeve
- Ensure that the pole strap is always above the position of the D rings
- An energy absorbing lanyard attached to the rear or front D is recommended as a backup provision.

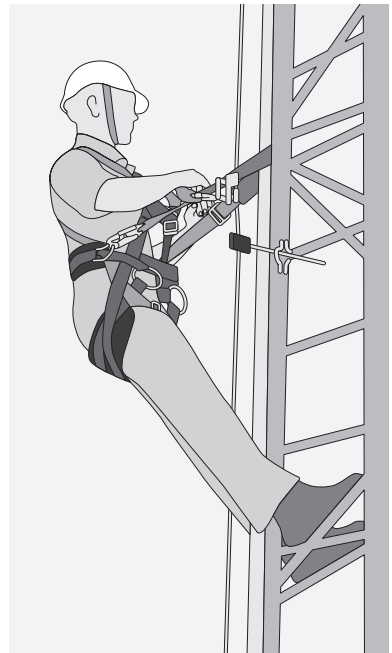

# Types of Connectors

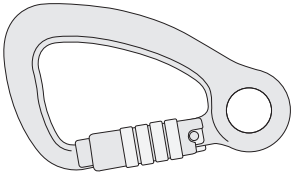

Triple lock karabiner with captive eye

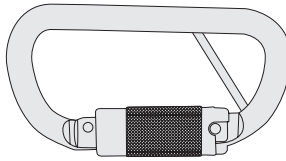

Triple lock karabiner with captive bar

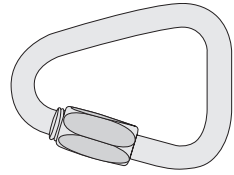

Delta quick link

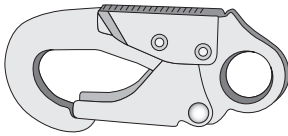

Double action safety hook - heavy duty

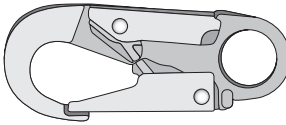

Double action safety hook

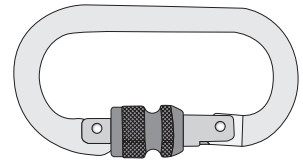

Screwgate karabiner

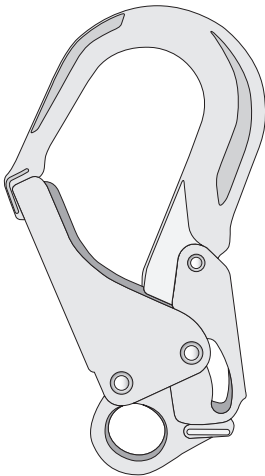

Double action scaffold hook - heavy duty

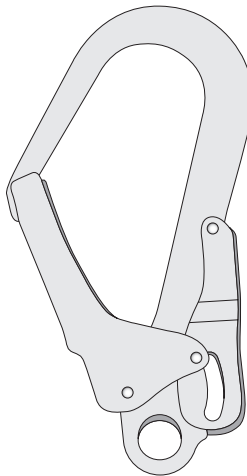

Double action scaffold hook

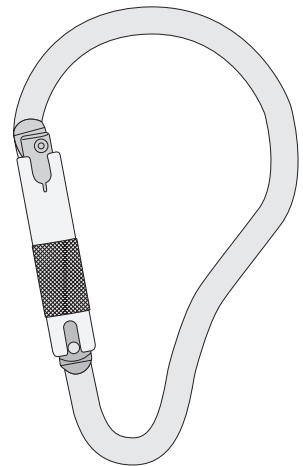

Triple action scaffold karabiner

**Note:** Connectors conforming to AS1891.5 must have a gate resistance (face and side) of 6kN minimum.

# Connector Instructions

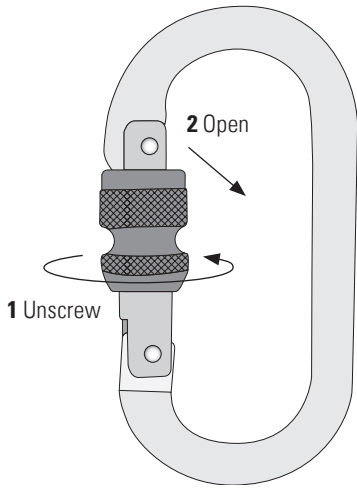

Screwgate karabiner

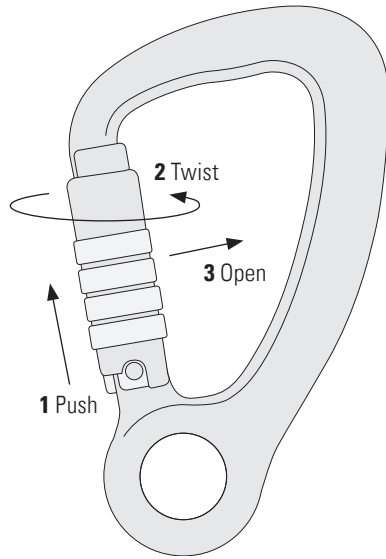

Triple lock karabiner

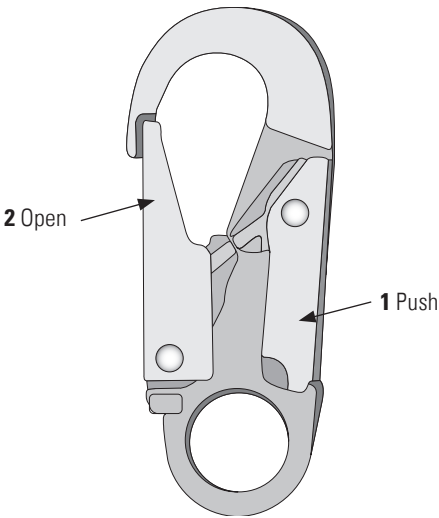

Double action safety hook

## WARNING:

- Always ensure that all gates are closed and locked tight prior to use
- Check for smooth spring and gate function prior to use
- Check for corrosion, distortion or damage prior to use
- Ensure all springs and gates are free of dirt and dust
- Never connect two snap hooks together
- Ensure any locking latch is furthest from the body when making a connection
- Do not use snap hooks or karabiners for lifting or towing
- Do not apply a load to the gate
- Avoid overcrowding.

# Anchorage

An anchor is the means for attaching a lanyard, lifeline or other components to a secure point. Anchorages for fall arrest systems can be fixed or temporary:

- Fixed. Such as machinery mounts, structural columns, steel roof beams, eye bolts, installed and labelled anchorages.
- Fixed or temporary horizontal life lines.
- Fixed or temporary vertical life lines.

## Selecting an Anchor Point

Solid anchor points are crucial to safe working at height – the best PPE available will not save you if you are attached to a loose, weak or rusty structure. Load testing of every potential anchor point is impractical, as is the installation of purpose designed fall arrest anchorage in every situation; therefore the majority of decisions made about what is a safe anchor point are based on experience and common sense.

The first factor to be considered is the load that the anchor point is expected to take, this is not always straightforward as ones bodyweight can exert a wide range of forces dependant on the intended use and configuration of the anchorage system.

Much structural steelwork, in good condition, will easily exceed this requirement. If any doubt exists, the site or plant engineer should be consulted.

Selection of the type and location of anchorages will depend on the nature and location of the task and the type of construction of the building or supporting structure. A summary of the types of anchorage, their strength requirements and their application is given in the table below.

## Anchor Straps

When rigging an anchor with a sling or pair of slings, the angle between the two legs or slings has a direct bearing on the strain induced in each sling and anchor point.

The maximum angle between two legs of a sling anchor system, whether formed with slings or rope should not exceed 120 degrees. At 120° each side of the system carries 100% of the load. Any angle greater than 120° means that the load is multiplied and may become hazardous, anything less than 120°, the load is divided and therefore safer. The optimum and safest angle is 50° or less.

## Load Table for Anchorages

Use	Number of Persons	Ultimate Load
Fall Arrest	One Person	15kN
Fall Arrest	Two People	21kN
Rope Access	One Person	12kN
Restraint	One Person	15kN
Diversion	One Person	12kN

Note: 1kN = 101.97kgf

Refer to AS/NZS1891.4 for further guidance

# Anchors

## Rigid Anchors

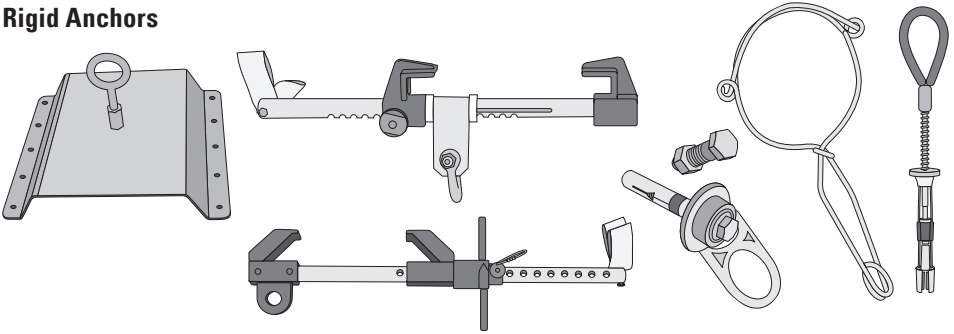

(Refer to individual instructions for rigid anchors)

## 3500 Series Anchor Straps and Black Snake

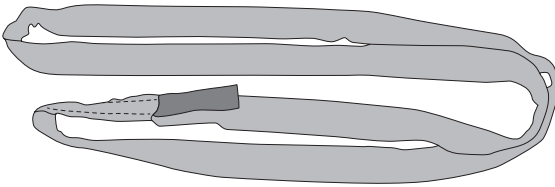

3506 Spectre round sling

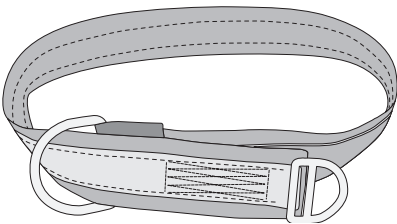

3501 anchor strap



Black snake

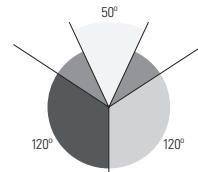
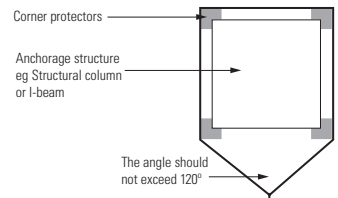

Note: 120° is 1/3 of a circle

Working or safety line



# Horizontal Lifelines

## 3400 Series

Temporary horizontal lifelines provide fall protection when working at or near exposed edges for short durations, or one off jobs.

Most temporary systems are designed for a maximum of either one or two workers per lifeline. The worker is attached to the lifeline via retracting lanyard or shock absorbing lanyard. Potential line deflection in the event of a fall may add several metres to the total clearance required. The line should be rigged as high as possible in relation to the user to minimise potential free falls. SpanSet horizontal lifelines have a maximum span of 18 metres.

Tools and equipment should not be suspended from the lifeline.

For regular and routine access protection, a permanent system should be installed.

Do not join two horizontal lifelines together! The 3400UK attaches to the D rings supplied on the webbing lifeline.

**Note:** SpanSet recommend both anchor points must have a minimum rating of 22 kN for 1 person and 40kN for 2 people.

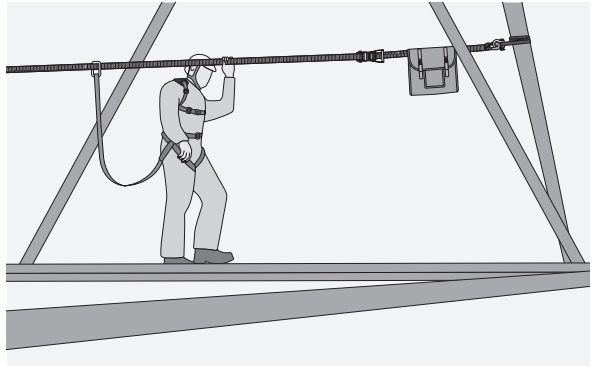

Example of a correctly rigged 3400UK

## Anchorage Attachments Required

Preferred methods of attaching the horizontal lifeline to a structure can include the following:

Method	1 person	2 people
Round slings	> 22kN in ultimate strength	> 40kN in ultimate strength
Flat slings	> 22kN in ultimate strength	> 40kN in ultimate strength
Wire slings	> 22kN in ultimate strength	> 40kN in ultimate strength
Grade 80 self locking lifting hooks	> 22kN in ultimate strength	> 40kN in ultimate strength
Safety shackles	> 22kN in ultimate strength	> 40kN in ultimate strength

**Do not use karabiners for anchoring horizontal safety lines. Ensure the structure you are attaching to will withstand the above lateral forces.**

**Recommended Rigging Method**

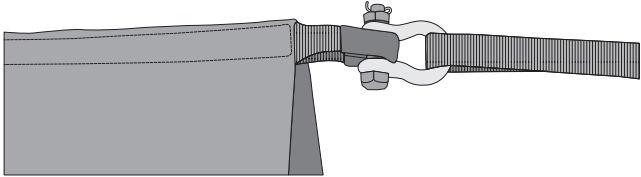

**3400UK – Two Man System**

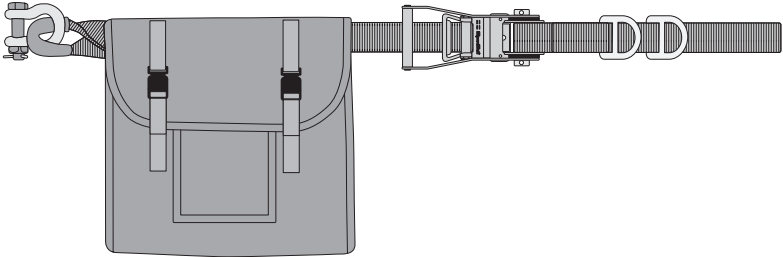

**Line Deflection Allowances**

To be added to fall clearance calculations†

Length of HLL	Deflection Allowance†
10m	1.0m
14m	1.4m
18m	1.85

† Based on 2m free fall with energy absorbing lanyard

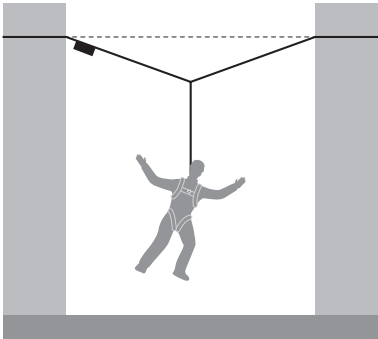

# Horizontal Lifeline Tensioner Instructions

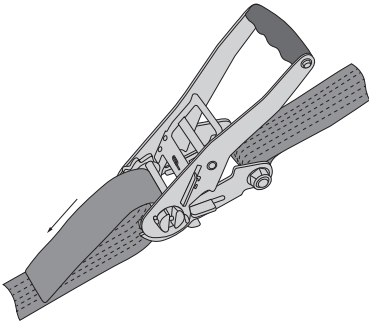

## Feeding the Webbing

Begin with the ratchet closed, pull back the function slide and open the ratchet handle to the upright position in front of the heel. With the spindle slot in a convenient position, feed the loose end of the webbing below the web guide bar and up through the slot in the spindle. Pull through until the webbing is taught.

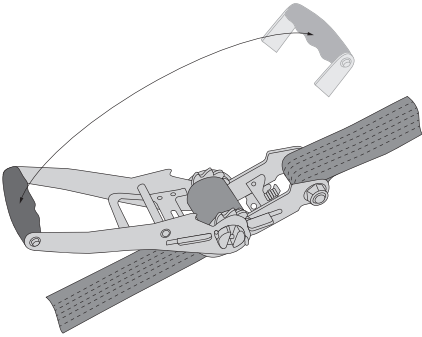

## Tensioning

The handle design enables high tensioning forces to be achieved. With the handle in the tensioning zone, operate the ratchet handle backwards and forwards to tension the webbing. A minimum of two complete turns of webbing must be applied to the spindle.

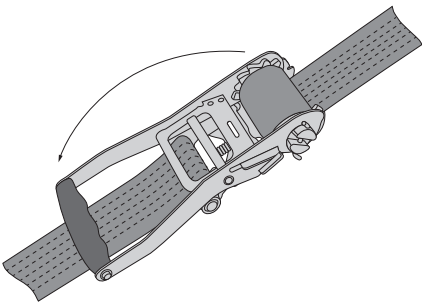

## Securing

Once the webbing is tensioned, pull back the function slide and pull the ratchet handle down flush to the ratchet body. Release the slide so that it locks the handle in the closed position. The ratchet cannot spring open due to rattling or vibration.



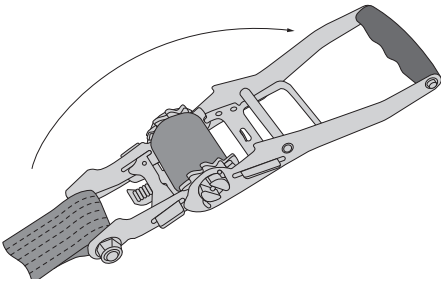

### Opening

Pull back the slide and open the ratchet handle through 180° to the end stop. Release the slide into the final open notch. The spindle can now freewheel and the webbing can be freed and pulled through.

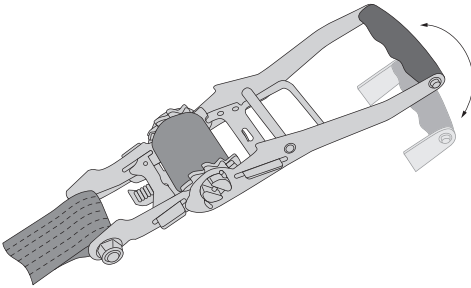

### Step-by-Step Release

Pull back the function slide and position the ratchet handle at approximately 100°, releasing the slide past the heel position into the Step-by-Step zone. The tension in the webbing strap can now be released gradually by rocking the ratchet handle to and fro (16 clicks is equivalent to approximately 1/2 turn of the spindle).

To re-tension the webbing simply reposition the ratchet handle in the tension zone as point 2 and lock the handle as point 3.

## Adjustable Rope Anchorages

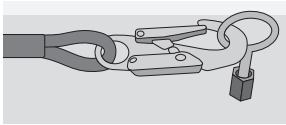
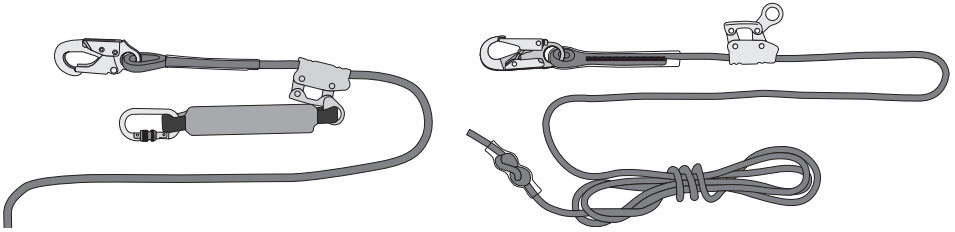

### Step 1

Connect safety hook to a suitable anchorage which has a minimum strength of approximately 15kN (1.5 Tonnes).

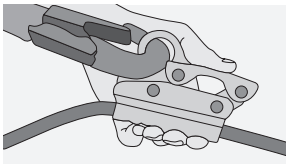

### Step 2

Where no integral energy absorber is fitted, connect the free end of an approved energy absorbing lanyard to the eye of the adjuster, with the energy absorbing pack connected to the fall arrest attachment of your harness.



### Step 3

To adjust the length of the line, squeeze the adjuster and move away from the anchorage point. Always ensure line is taut between you and the anchorage. To shorten the line, reverse the process ensuring the line remains taut at all times.

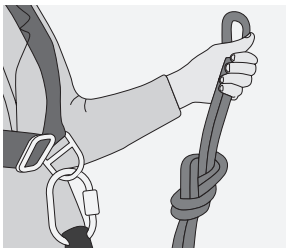

### Step 4

Tie a figure 8 knot in the end of the rope (jamming knot), leaving a 600mm tail, and in a position which will not allow you to step off the edge of the work structure without the adjuster jamming against the knot.

## Vertical Fall Arrest Lines (Type 1) Fall Arrest Device

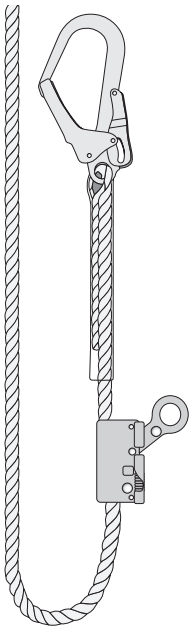

### Warnings

- Only connect to a structure capable of withstanding 15kN which is above the head of the user.
  - Connect to harness via a mini shock absorber or attachment strop no longer than 300mm
  - Maximum allowable weight 136kg. 1 person only
  - Should a fall occur, do not manipulate rope grab, await rescue
  - Not suitable for controlled descent applications
  - Do not attempt to repair this device. If damaged, corroded or worn, remove from service and discard
  - If rope grab has arrested a fall, do not re-use
  - Ensure rope grab is completely enclosed and locked around lifeline
- and is attached to the rope with the arrow pointing upwards toward the anchorage
  - Do not use rope grab if it fails to lock onto the rope completely
  - Do not hold the rope grab cam in the open position
  - Never disconnect from the lifeline unless you are protected from falling by another approved method
  - Observe general chemical warnings
  - Ensure the lifeline does not contact sharp edges or abrasive surfaces
  - Attach a weight to the bottom of the rope to stop rope from creeping up with climber
  - Check the operation of the rope grab by moving up and down and applying a sharp jerk downwards to check brake function.

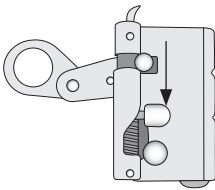

**1** Push knurled knob towards button

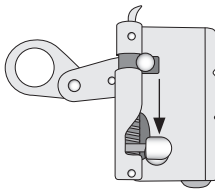

**2** Depress spring loaded button

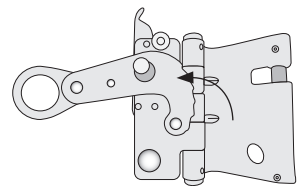

**3** Open unit to insert rope

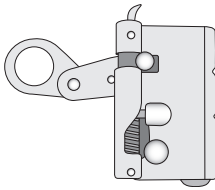

**4** Close unit, listen for distinctive click

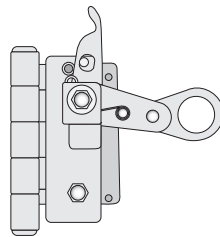

**Open** - Lever in open position

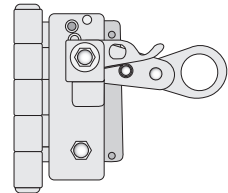

**Parked** - Lever in parked position

# Suspension Trauma

Suspension trauma, or orthostatic intolerance, is a natural human reaction to being upright and immobile, where blood pools in the legs leading to unconsciousness.

It can be caused by suspension in a harness (deliberate or accidental), when trapped in a confined space, when secured to a vertical stretcher or litter - any situation where you are forced to stay upright without standing. If it is allowed to develop unchecked, it can be fatal.

With the use of a fall-arrest system, suspension trauma may occur when a person has an arrested fall because they are suspended and are caught in an upright, vertical position and the harness straps cause pressure on the leg veins.

The blood flow to the heart is reduced, resulting in fainting, restriction of movement or loss of consciousness in a few minutes. This may lead to renal failure and eventually death, depending on a person's susceptibility. The condition may be worsened by heat and dehydration.

A person suspended in a harness from the rear dorsal ring is also vulnerable to asphyxiation; should fainting occur the head falls forward and the airway is blocked.

In clinical trials, although some subjects experienced no effects after prolonged suspension, others experienced fainting or loss of consciousness in just a few minutes.

The initial indications are that a person's susceptibility may be unrelated to fitness level or any other physical condition or attributes. Therefore, the quick rescue of a person suspended in a full body harness, as soon as possible, is vital. For this reason, workers should be capable of conducting a rescue of a fallen worker and be familiar with onsite rescue equipment and procedures.

Suspension relief straps offer short term relief only and the correct approach is to have a pre-rigged rescue kit such as a SpanSet Gotcha™, along with trained personnel to deal with a potential emergency.



## Use of SG238 Suspension Trauma Relief Straps

- 1** Locate, unzip and deploy each case containing the suspension relief straps.
- 2** Raise the ends of the two straps to reach the hook and loops. Fit the hook through the loop that will give you the required length and lower the straps.
- 3** Step onto the strap to relieve the pressure on the legs and groin. Repeat step two and three if the length is not suitable.

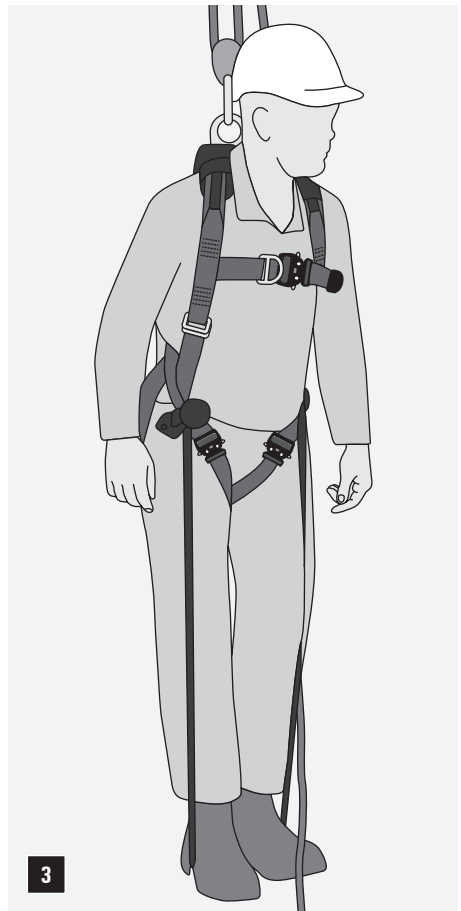
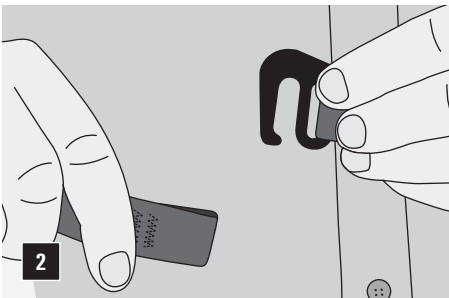

## 4006—Confined Space Spreader Bar

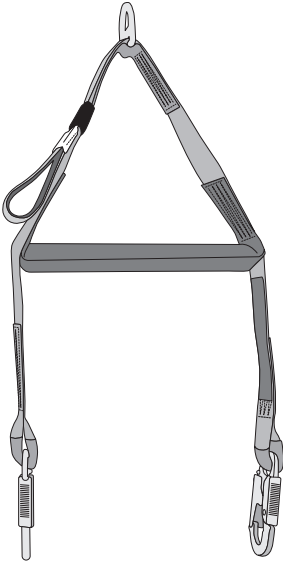

The SpanSet 4006 spreader bar is for use in tight confined space entry applications in line with AS2865 – Safe Working In a Confined Space. It enables a worker to be lifted or lowered while maintaining a straight vertical profile which is not available with a rear D connection. This allows the worker to manoeuvre through tight manholes etc.

- Ensure correct and safe connection of the upper D ring to the connector of the lifting/lowering device prior to suspension.
- Connect both snap hooks to the marked attachment points on the harness, ensuring the double action snap hooks fully close and lock.
- This device is for lifting and lowering only and is not to be used as a fall arrest attachment
- Where required, a wrist restraint loop is provided on the upper section of the spreader bar which aides in further narrowing of the shoulders during a rescue situation.
- This product is required under AS1891.4 to be inspected on a six month cycle or more often if used in an aggressive environment.

---

## FPV8020—Bosun’s Chair

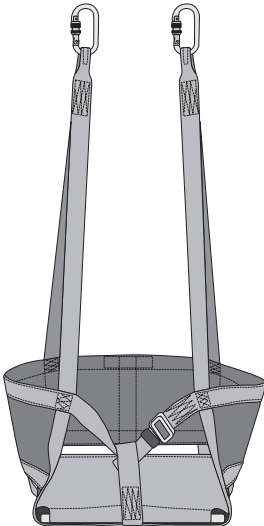

The SpanSet Bosun’s chair is a work positioning device only and is not a fall arrest device. It is used in tandem with the 4006 Spreader Bar for short term suspension only. Commonly used with a personnel winch or pulley system. Operators using this equipment must be wearing a full body fall arrest harness (e.g. 1100 ERGO or similar) and be connected to an independent anchorage line via an energy absorber or lanyard (e.g. 3109 Fall Arrest Anchorage Line, 3051 Energy Absorber).

- Connect both snap hooks to the overhead loops on the Bosuns Chair, ensuring the double action snap hooks fully close and lock
- This device is for lifting and lowering only and is not to be used as a fall arrest attachment
- This product is required under AS1891.4 to be inspected on a six month cycle or more often if used in an aggressive environment.

# Training

The SpanSet method of training has been set up to offer a clearer explanation of the options available in Height Safety, Confined Space, Inspection, Evacuation and Vertical Rescue training. Our approach allows us to deliver consistent and concise training specific to the clients needs. Extra activities can be added into the training to further enhance the candidate's skills.

SpanSet trainers are highly qualified personnel, all with extensive industry experience. SpanSet delivers training across a wide range of industries such as mining, telecommunications, theatre, councils, government authorities, ports, power authorities, construction and oil and gas drilling rigs. SpanSet can supply all training equipment upon request.

Each course sets out the following:

- The course duration
- Trainee to instructor ratio
- Course content
- Course split between theory and practical sessions.

## How it Works

The basis of all of the height safety training courses is Working Safely At Heights Theory and Practical. This provides all trainees with a solid foundation in safe work at heights from which they move on to the practical module to complete their competency as a height safety operator. Trainees can then choose extra courses to further enhance their qualifications and skills to height safety supervisor or manager.

## Certification

- RIIWHS204D Work Safely at Heights; or
- CPCPCM2010A Work Safely at Heights; or
- CPCPCM2035A Work Safely on Roofs.

A Statement of Attainment in either RIIWHS204D Work Safety at Heights, CPCPCM2015A Work Safety on Roofs, or CPCPCM1006A Work Safety at Heights will be issued to candidates who have successfully completed both practical and theory.

## Height Safety Training

These courses are structured to provide candidates with the necessary practical skills and theoretical understanding to undertake work at height on a broad range of structures and differing environments; as well as working safely in the vicinity of unprotected edges or on steep ground.

## Rescue Training

These courses provide candidates with the skills and knowledge to set up and conduct rope rescue of a suspended or injured casualty using a pre-rigged proprietary rope rescue system. Includes necessary skills to respond to a variety of post-fall rescue situations such as high/low anchor rescue, casualty evacuation, rescue off inertia reels, rescue off vertical lifelines and off towers, masts or structures.

## SpanSet Training Courses

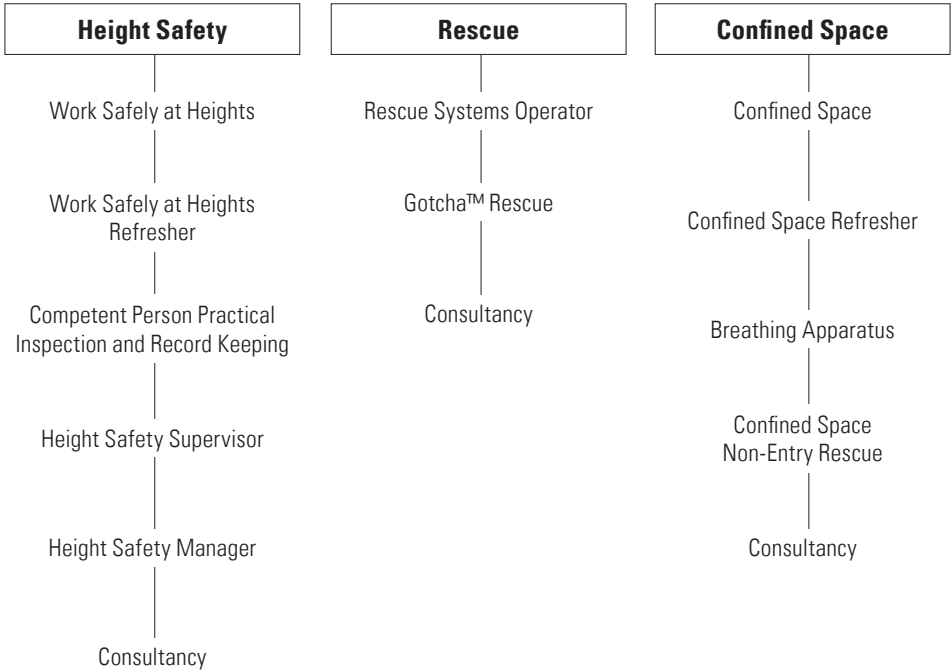

### To make a booking:

Please contact our SpanSet Australia Ltd training coordinator.

Phone: 02 4735 3955

Fax: 02 4735 3630

Email: [training@spanset.com.au](mailto:training@spanset.com.au)

Web: [www.spanset.com.au](http://www.spanset.com.au)

Address: SpanSet Australia  
Training Centre  
150 Old Bathurst Road  
Emu Plains NSW 2750  
On site parking available



# General Maintenance

- A visual check should be carried out before and after daily use, and a 6 monthly periodic inspection is to be performed by a competent person and the results recorded.
- Clean prior to inspection.

## Checklist for Inspection of Harnesses and Pole Straps

The following points should be checked before use:

- Check all webbing for effects of cuts, tears, abrasion, heat, chemicals, corrosives or solvents, hardening, excessive stretching, glazing due to friction, excessive wear or fuzziness, discolouration due to chemical contamination or prolonged ultraviolet exposure, excessive stiffness due to overloading, possibly as a result of a fall.
- Check all stitch blocks for broken, cut or worn stitching and damage due to heat, corrosives, solvents or mildew
- Check all buckles and D-rings for deformation, distortion, corrosion, wear and correct orientation
- Ensure the protective sleeve is in place on the pole strap
- Check ID number and Standards logo for legibility
- Check Date of manufacture - life shall not exceed 10 years
- Check for evidence of a fall. Must be withdrawn from service after a fall and destroyed if any damage has been sustained
- Check with the user for possible causes of damage.

If any of these points are not satisfactory then the harness should be destroyed.

## Inspecting iWeb Enabled Products

Webbing with iWeb is woven with a contrasting (red) core of load bearing webbing which runs the full width and length of the webbing. To inspect, simply look for signs of red in any abrasion point, scuff, or cut on the surfaces or edges. This gives an objective inspection and discard criteria for both the user and the competent inspection person to apply.

## Checklist for Inspection of Lanyards

### Polyester Components

- Label present with date of manufacture - from date of manufacture life shall not exceed 10 years
- Cuts and abrasion to rope or webbing
- Cuts and abrasion to stitching
- Glazing or crispiness - due to friction, heat damage or possible chemical contamination
- Damage due to contact with heat, corrosives, chemicals and solvents
- Discolouration - due to chemical contamination or prolonged UV exposure
- Excessive stiffness - due to overloading, possibly as the result of a fall.

### Energy Absorbers

- ID label present with date of manufacture – check remove from service date
- Visual check of attachment points
- Visual check of tear out element, checking for any signs of deployment or length extension

Adjustment and attachment devices should be function tested according to type and visually checked as per page 19 of this manual.

If any of these points are not satisfactory then the lanyard should be destroyed.

### Inspecting iWeb Enabled Products

Webbing with iWeb is woven with a contrasting (red) core of load bearing webbing which runs the full width and length of the webbing. To inspect, simply look for signs of red in any abrasion point, scuff, or cut on the surfaces or edges. This gives an objective inspection and discard criteria for both the user and the competent inspection person to apply.

-----

### Washing Instructions

SpanSet Australia discourages the washing of fall arrest harnesses and associated equipment in industrial laundry facilities due to the severity and unknown nature of the solvents and cleaning agents used.

The preferred method is to use a mild, domestic soap, rinsed, then hung to dry naturally out of sunlight.

If a washing machine is used then the product should be placed in a mesh bag in order to avoid damage to the fittings and entanglement.

Do not use pressure sprays to clean harnesses, lanyards or webbing products.





---

### **Head Office**

SpanSet Australia Ltd  
150 Old Bathurst Road  
(PO Box 164)  
Emu Plains NSW 2750

Phone: +61 2 4735 3955

Fax: +61 2 4735 3630

[sales@spanset.com.au](mailto:sales@spanset.com.au)

[www.spanset.com.au](http://www.spanset.com.au)

---

### **Western Australia Office**

Unit 1, 50 Tulloch Way  
Canning Vale WA 6155

Phone: +61 8 9455 7404

Fax: +61 8 9455 3477

---

We love to hear from our customers! If you have suggestion, an issue with the product, or simply want to chat please don't hesitate to email us at [sales@spanset.com.au](mailto:sales@spanset.com.au) or call direct.