

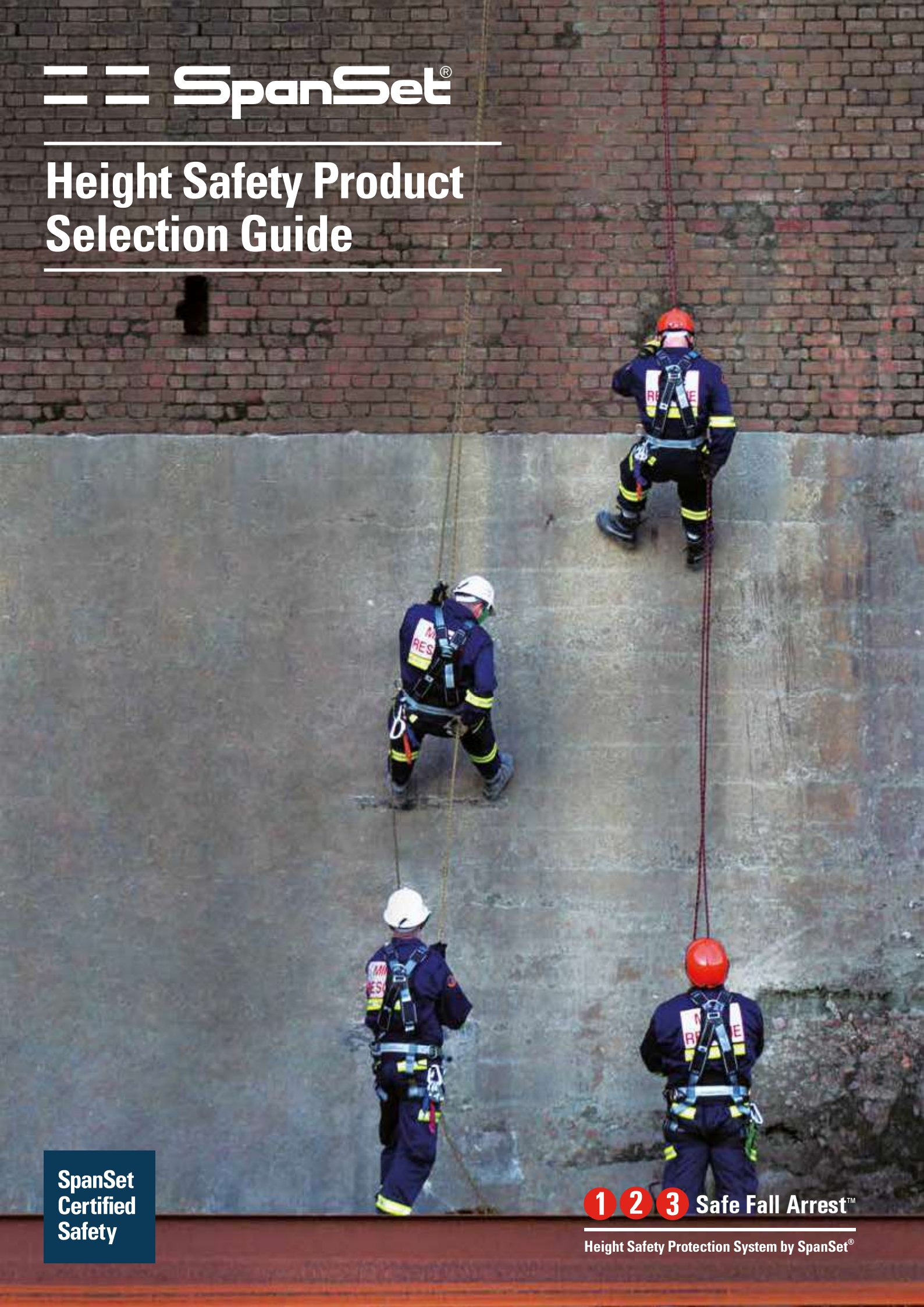

Height Safety Product Selection Guide



SpanSet
Certified
Safety

1 2 3 Safe Fall Arrest™

Height Safety Protection System by SpanSet®

Contents

Part 1 Height Safety Product Selection Guide

Introduction	3
1 2 3 Safe Fall Arrest™ Height Safety Protection System	3
Working on Ladders, Poles, Towers and Structures	4
Working on Live edge	4
Working with Horizontal Safety Lifelines	5
Working on Roofs	5
Order Picker Fall Protection	6
Elevating Work Platforms (EWP)	6
Working on top of Vehicles	7
Working on Scaffolding	7
Fall Arrest/SRL Devices	8
Hot Work Applications	8
Gotcha™ Rescue Kit Application	9
Working with Tripods - Setup 1	9
Working with Tripods - Setup 2	10
Working with Tripods - Setup 3	11

Part 2 Product Catalogue

Safety/Rescue Kits	12
1 Harnesses	12-14
2 Connectors	14-17
3 Anchors	17-18
Xtirpa for Confined Spaces	19
SpanSet Training Services	19

Subject to technical alterations. All rights reserved. No part of this catalogue may be reproduced or processed, duplicated or distributed using electronic systems in any form (print, photocopy, microfilm or any other procedure) without the written approval of the SpanSet company. This catalogue has been prepared with all due care; SpanSet accepts no liability for errors or omissions.
© April 2019 by SpanSet Australia Ltd.

Introduction

SpanSet® height safety products are designed to reduce the impact and distance of a fall in accordance with Australian Standards (AS/NZS 1891). To comply with Australian Standards and maintain safety when working at heights, there are three minimum requirements that must be fulfilled in order to create a complete fall arrest protection system.

This *Height Safety Product Selection Guide*:

1. Explains what the requirements are to maintain safety in different worksite scenarios through a series of illustrations (Part 1: pages 3-11).
2. Lists the specifications for all products featured in Part 1, giving more insight into the features and benefits of SpanSet® height safety products (Part 2: pages 12-19).

This guide is for the training of sales staff only, and should be used to train sales staff in the **123 Safe Fall Arrest™ - Height Safety Protection System**, so that they can assist customers select the correct product, creating a 'complete' fall arrest protection system.

This guide does NOT substitute *Working Safely At Heights* training. ALL OPERATORS OF HEIGHT SAFETY EQUIPMENT REQUIRE TRAINING. Contact SpanSet Training Services on 02 4735 3955 for assistance.

Any setup/installation of height safety systems requires a risk assessment to be performed in a safe working manner. A rescue plan is also an essential component of working safely at heights. The SpanSet team of height safety specialists can provide assistance on how to set up/maintain a safe working environment.

Here at SpanSet we take pride in keeping our customers safe. Your safety is our objective.

1 2 3 Safe Fall Arrest™

Height Safety Protection System by SpanSet®

Select a **harness, connector and anchor** to maintain safety when working at heights.
(All three components must be selected)

1 Harness

A harness connects a worker to components of a fall arrest system through attachment points.

Harness Range: ERGO, ERGO Lite, ERGO iPlus, HotWorks, WaterWorks, Spectre/Tradie.



2 Connector

Connectors with an energy absorber, securely attach a harness to an anchorage device.

Types of Connectors: Energy Absorbing/Retracting Lanyards, Self Retracting Lifelines (SRL), Fall Arrest Blocks/Inertia Reels, Rope Anchorage Lines (with an energy absorber).

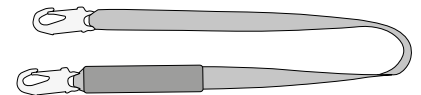

3 Anchor

Anchorage devices secure a worker to an existing structural element and can be fixed or temporary. The anchor can also be a suitable structure/anchor point, or a work positioning device.

Types of Anchors: Beam Anchors, Horizontal Safety Lines, Hard Point Anchors, Attachment Slings, Pole Straps or FASTLINK Temporary Roof Anchor.

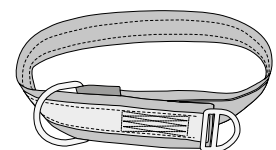

NOTE: SKETCHES ARE NOT TO SCALE AND ARE A SALES GUIDE ONLY. THIS GUIDE DOES NOT REPLACE WORKING SAFELY AT HEIGHTS TRAINING. FOR PRODUCT SPECIFICATIONS REFER TO PAGES 12-19.

Working on Ladders, Poles, Towers and Structures

1 HARNESS

- 1107 ERGO
- 1300 ERGO
- 1500 ERGO Tower Worker
- 1800 ERGO Rescue/Rope Access

2 CONNECTOR

- 3058 ACCESS Energy Absorbing Twin Leg Lanyard
- 3058E ERGO Energy Absorbing Twin Leg Elasticated Lanyard
- SpanSet SVLB-DSL2 or SVLB-DSL2-ALU Double Dynamic Self Retracting Lanyard

3 ANCHOR

- 2700-RP 2.5m Adjustable Pole Strap (other lengths available upon request).

NOTE: For hot work applications where pole work is required, use either an 1107 or 1300 HotWorks harness, with a 3058 HotWorks Twin Leg Lanyard and a 2700 HotWorks Pole Strap.



Working on Live Edge

1 HARNESS

- 1100 TRADIE
- 1100 ERGO-BP
- 1100 ERGO iPlus
- Any SpanSet harness will suit this application

2 CONNECTOR

- 3053-GP General Purpose Energy Absorbing Lanyard
- 3055 SCAFF Energy Absorbing Lanyard with Scaffold Hook
- 3201 Retracting Lanyard
- SVLB-2 Saverline 2 metre Fall Arrest Block
- Saverline Self Retracting Lifeline (SRL)

3 ANCHOR

- 3506-BS-RP 1m Black Snake Attachment Anchor Sling
- 3501-BP Anchor Strap

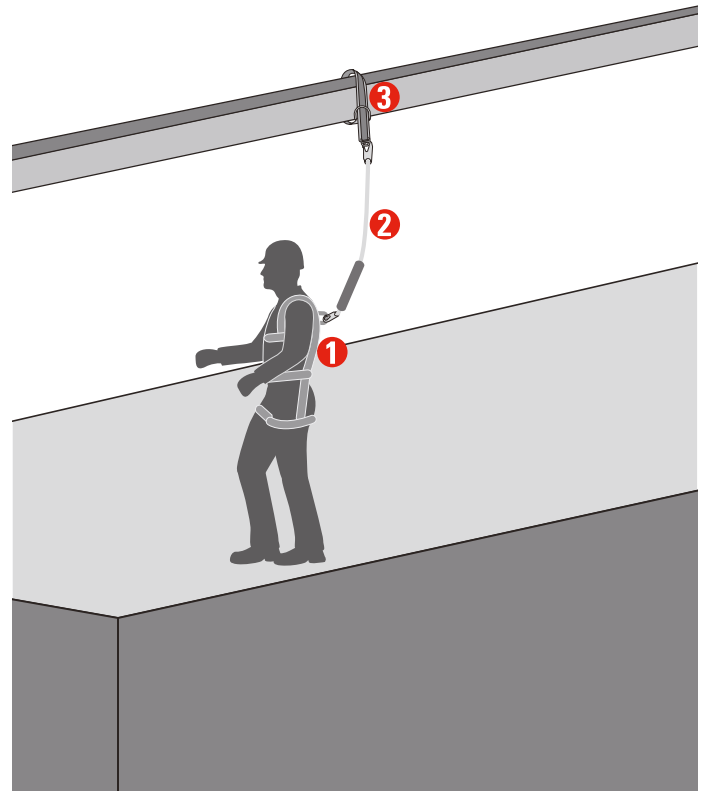

NOTE: SKETCHES ARE NOT TO SCALE AND ARE A SALES GUIDE ONLY. THIS GUIDE DOES NOT REPLACE WORKING SAFELY AT HEIGHTS TRAINING. FOR PRODUCT SPECIFICATIONS REFER TO PAGES 12-19.

Working with Horizontal Safety Lifelines

1 HARNESS

- 1100 ERGO-BP
- 1100 ERGO iPlus
- 1100 ERGO Lite
- Any SpanSet harness will suit this application

2 CONNECTOR

- 3053-GP General Purpose Energy Absorbing Lanyard
- 3055 SCAFF Energy Absorbing Lanyard with Scaffold Hook
- 3058 ACCESS Energy Absorbing Twin Leg Lanyard
- 3058E ERGO Energy Absorbing Twin Leg Elasticated Lanyard
- 3058E ERGOplus Energy Absorbing Twin Leg Elasticated Lanyard
- 3201 Retracting Lanyard
- SVLB-2 Saverline 2 metre Fall Arrest Block
- Saverline Self Retracting Lifeline (SRL)
- SpanSet SVLB-DSL2 or SVLB-DSL2-ALU Double Dynamic Self Retracting Lanyard

3 ANCHOR

- 3400 x 18m 1 Person or 3400UK 2 Person Horizontal Safety Line

NOTE: 3400 Series kits are supplied with two safety shackles. Additional attachment slings are required to secure a 3400 Series kit to a structure. Use 3506-BS-RP or 3501-BP anchors.

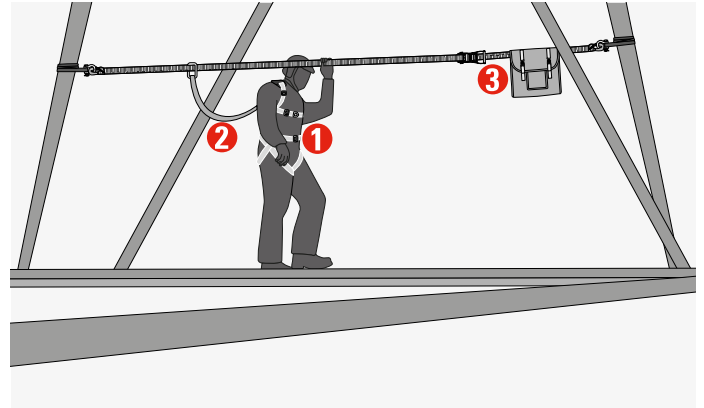

Working on Roofs

1 HARNESS

- 1100 TRADIE
- 1100 ERGO-BP
- 1104 ERGO-BP
- 1100 ERGO iPlus
- Any SpanSet harness will suit this application

2 CONNECTOR

- 3108SA-RP x 15m Energy Absorbing Anchorage Line with Rope Adjuster (Other lengths are available upon request).

3 ANCHOR

- 3506-BS-RP 1m Black Snake Attachment Anchor Sling
- FASTLINK Metal and Timber Temporary Roof Anchor

NOTE: The 6500 Bucket of Safety Roofer's Kit and 6001SA-SPECTRE-0 Roofer's Kit come complete with a harness, connector, and anchor sling/strap.

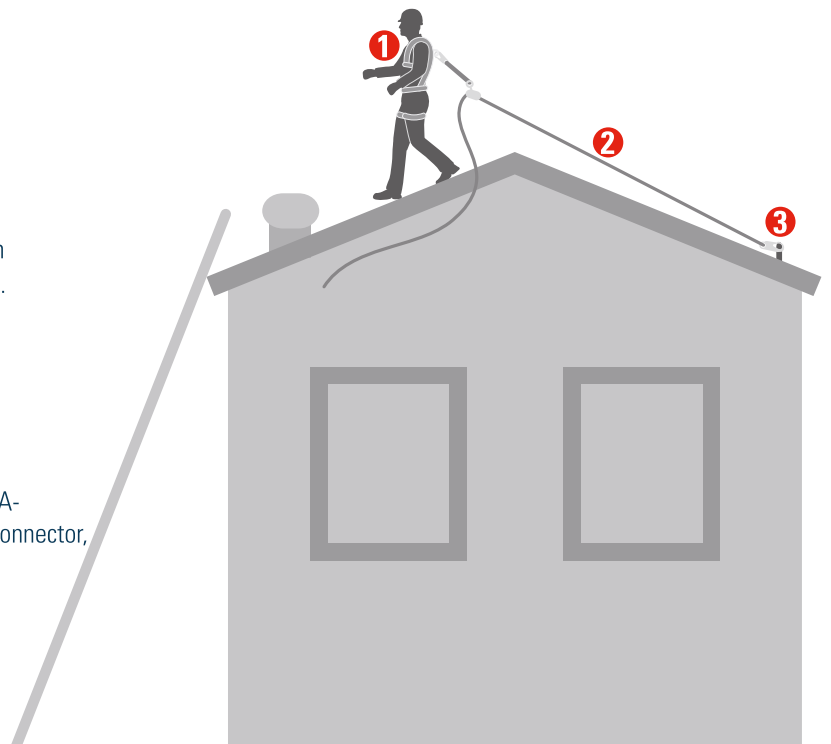

NOTE: SKETCHES ARE NOT TO SCALE AND ARE A SALES GUIDE ONLY. THIS GUIDE DOES NOT REPLACE WORKING SAFELY AT HEIGHTS TRAINING. FOR PRODUCT SPECIFICATIONS REFER TO PAGES 12-19.

Order Picker Fall Protection

1 HARNESS

- 1100 TRADIE
- 1100 ERGO-BP
- 1100 ERGO iPlus
- Any SpanSet harness will suit this application

1 HARNESS + 2 CONNECTOR

- 1150 EWP Full Body Harness and Lanyard combo

2 CONNECTOR

- 3053-GP General Purpose Energy Absorbing Lanyard
- 3055 SCAFF Energy Absorbing Lanyard with Scaffold Hook
- 3201 Retracting Lanyard
- SVLB-2 Saverline 2 metre Fall Arrest Block
- Saverline Self Retracting Lifeline (SRL)

3 ANCHOR

- Fixed anchor point on Order Picker

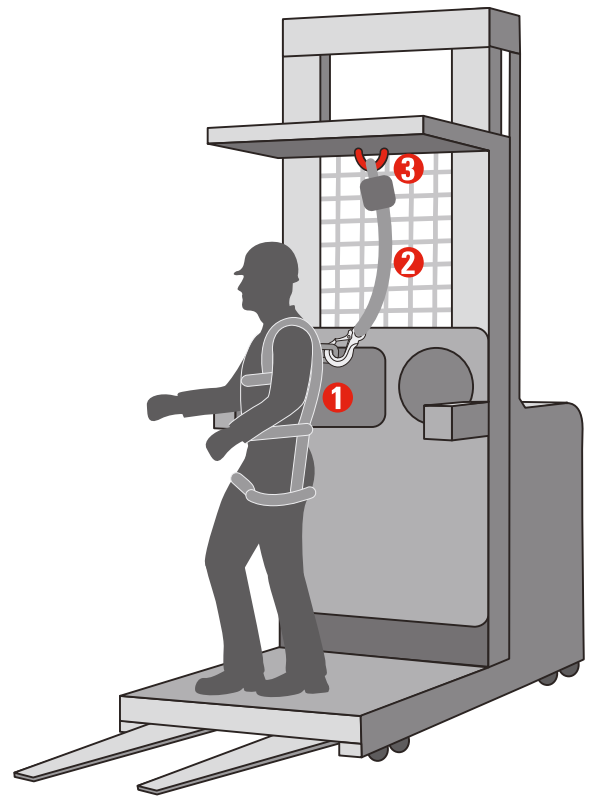

Elevating Work Platforms (EWP)

1 HARNESS

- 1100 TRADIE
- 1100 ERGO-BP
- 1100 ERGO iPlus
- Any SpanSet harness will suit this application

1 HARNESS + 2 CONNECTOR

- 1150 EWP Full Body Harness and Lanyard combo

2 CONNECTOR

- 3053-GP General Purpose Energy Absorbing Lanyard
- 3055 SCAFF Energy Absorbing Lanyard with Scaffold Hook
- Saverline 2002361/ACB 1.8 specially designed lightweight 0.96kg EWP SRL with short 1.8 metre lifeline and max arresting force of less than 3kN.
- Saverline 2002345/HWB 2
- Saverline 2002347/HWPB 3.5
- Saverline 2002346/HWPS 3

3 ANCHOR

- Fixed anchor point on EWP

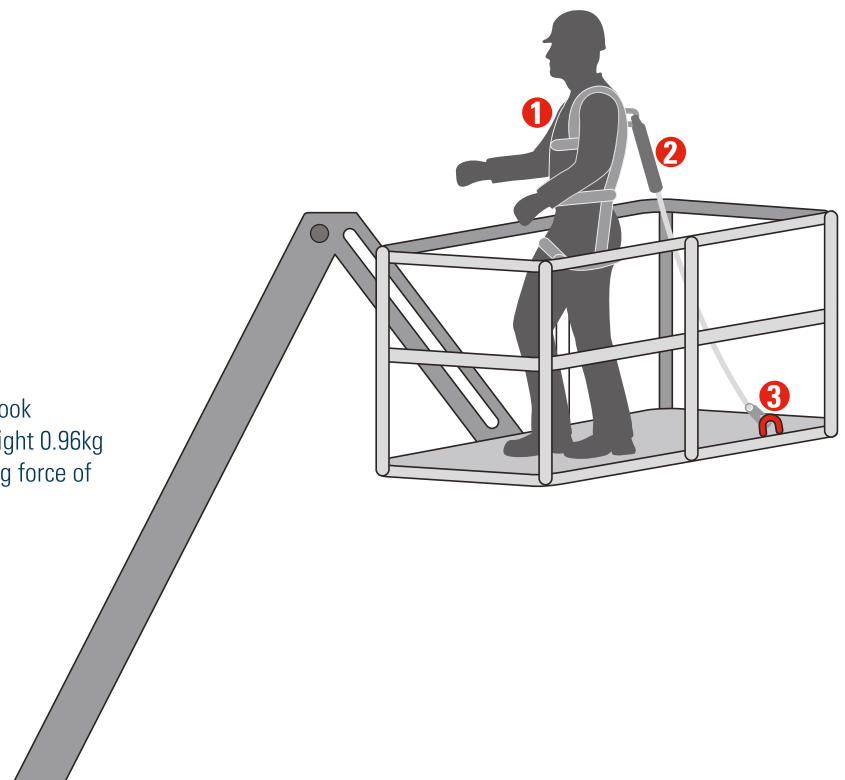

NOTE: SKETCHES ARE NOT TO SCALE AND ARE A SALES GUIDE ONLY. THIS GUIDE DOES NOT REPLACE WORKING SAFELY AT HEIGHTS TRAINING. FOR PRODUCT SPECIFICATIONS REFER TO PAGES 12-19.

Working on top of Vehicles

1 HARNESS

- 1100 TRADIE
- 1100 ERGO-BP
- 1100 ERGO iPlus
- Any SpanSet harness will suit this application

2 CONNECTOR

- SVLB-2 Saverline 2 metre Fall Arrest Block
- SVLB-3 Saverline 3 metre Fall Arrest Block
- SVLB-10 Saverline 10 metre Fall Arrest Block
- Saverline Self Retracting Lifeline (SRL)

3 ANCHOR

- 3506-BS-RP 1m Black Snake Attachment Anchor Sling
- 3501-BP Anchor Strap

NOTE: For lateral movement at anchor point, refer to SpanSet HT8 Permanent Horizontal Lifeline System. HT8 available up to 40m, 4 person systems. Please contact SpanSet for details.

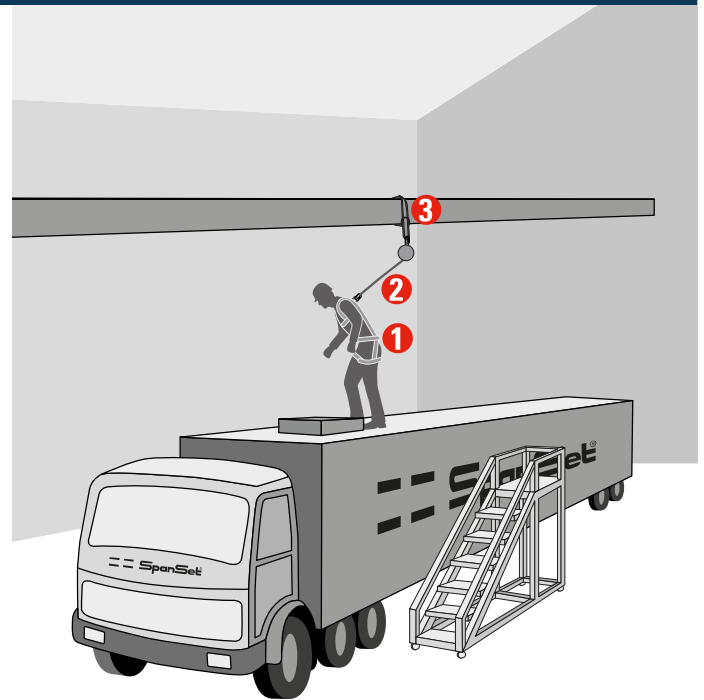

Working on Scaffolding

1 HARNESS

- 1100 ERGO-BP
- 1100 ERGO iPlus
- 1100 ERGO Lite
- Any SpanSet harness will suit this application

2 CONNECTOR

- 3058 ACCESS Energy Absorbing Twin Leg Lanyard
- 3058E ERGO Energy Absorbing Twin Leg Elasticated Lanyard
- 3058E ERGOplus Energy Absorbing Twin Leg Elasticated Lanyard
- SpanSet SVLB-DSL2 Double Dynamic Self Retracting Lanyard
- SpanSet SVLB-DSL2-ALU Double Dynamic Self Retracting Lanyard

3 ANCHOR

- Scaffolding can be used as an anchor point (a risk assessment is required).

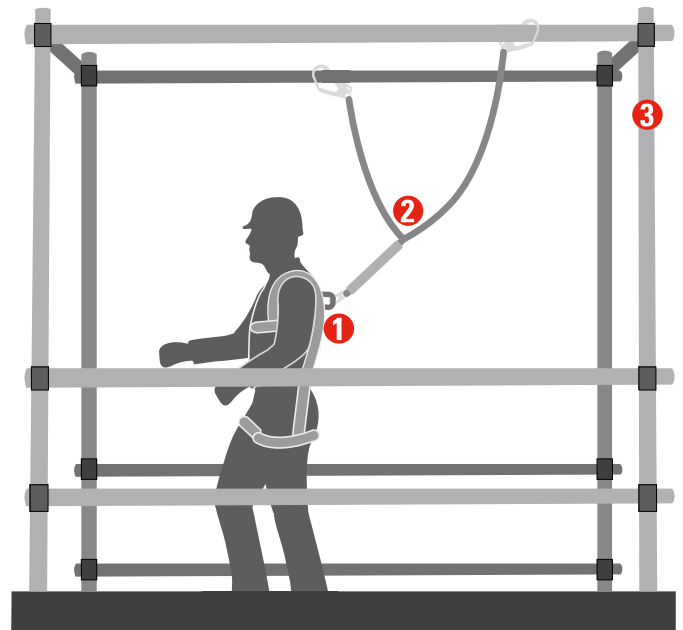

NOTE: SKETCHES ARE NOT TO SCALE AND ARE A SALES GUIDE ONLY. THIS GUIDE DOES NOT REPLACE WORKING SAFELY AT HEIGHTS TRAINING. FOR PRODUCT SPECIFICATIONS REFER TO PAGES 12-19.

Fall Arrest / SRL Devices

1 HARNESS

- 1100 TRADIE
- 1100 ERGO-BP
- 1100 ERGO iPlus
- Any SpanSet harness will suit this application

2 CONNECTOR

- 3201 Retracting Lanyard
- SVLB-2 Saverline 2 metre Fall Arrest Block
- Saverline Self Retracting Lifeline (SRL)

3 ANCHOR

- 3506-BS-RP 1m Black Snake Attachment Anchor Sling
- 3501-BP Anchor Strap
- Existing building structure (a risk assessment is required).

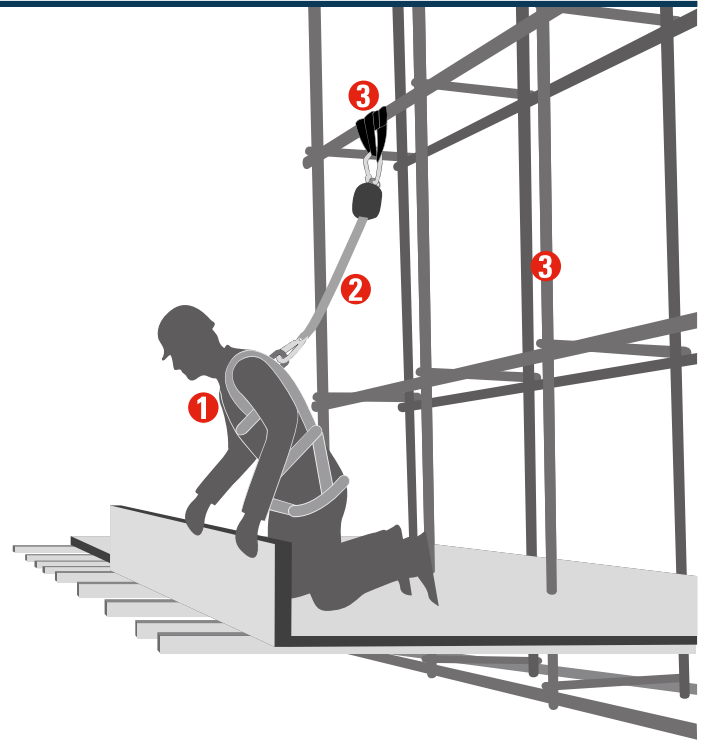

Hot Work Applications

1 HARNESS

- 1100 HotWorks
- 1107 HotWorks
- 1300 HotWorks

2 CONNECTOR

- 3053 HotWorks Energy Absorbing Lanyard
- 3055 HotWorks Energy Absorbing Lanyard with Scaffold Hook
- 3058 HotWorks Energy Absorbing Twin Leg Lanyard

3 ANCHOR

- 3501-HW-0x2.0 HotWorks Anchor Strap
- Existing fixed structure (a risk assessment is required).

NOTE: For hot work applications where pole work is required, use either an 1107 or 1300 HotWorks harness, with a 3058 HotWorks Twin Leg Lanyard and a 2700 HotWorks Pole Strap.

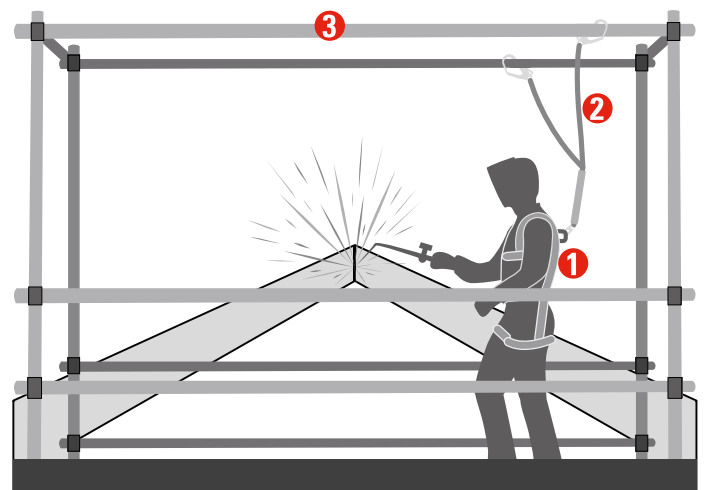

NOTE: SKETCHES ARE NOT TO SCALE AND ARE A SALES GUIDE ONLY. THIS GUIDE DOES NOT REPLACE WORKING SAFELY AT HEIGHTS TRAINING. FOR PRODUCT SPECIFICATIONS REFER TO PAGES 12-19.

Gotcha™ Rescue Kit Application

The Gotcha™ Original Rescue Kit (Code: GOTCHA-KIT-0; 50m rescue kit) was the first preassembled remote rescue kit. It is designed for rescuing a suspended casualty from fall arrest lanyards, rope safety lines and fall arrest blocks; which is all possible from a point of safety. The Gotcha™ Rescue Kit has enormous versatility and can be used:

- For rescue from confined spaces, ladders, towers, masts, structures, fall arrest lanyards, rope safety lines, and Inertia Reels/Self Retracting Lifelines (SRL).
- For specialist rescue team applications.
- For remote attachment using an Extension Pole and Gotcha Frog.
- For remote attachment using an Extension Pole and Gotcha Scaff Kit.
- As a hauling kit with a casualty litter or stretcher.
- With an overhead high anchorage.
- With a foot low level anchorage.

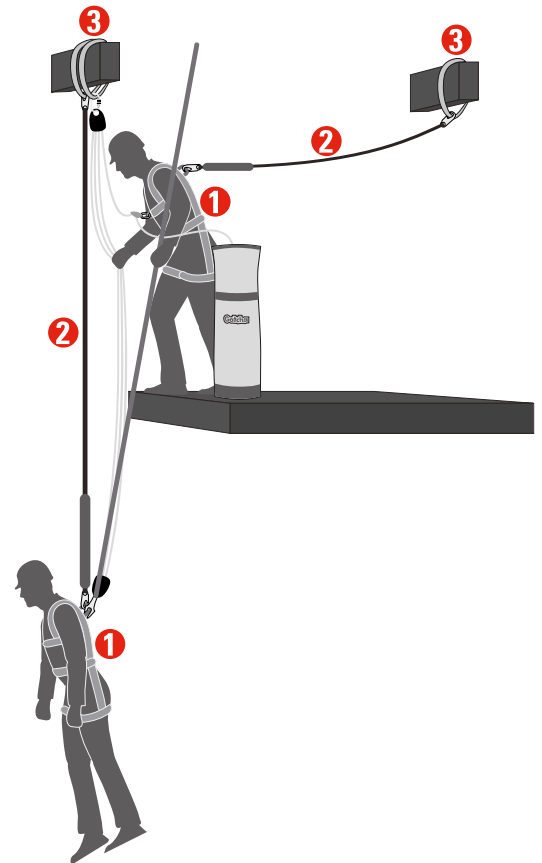

Working with Tripods - Setup 1

Primary fall arrest and rescue device. Set up when operator is required to enter a confined space via a ladder with a fall arrest/rescue device.

1 HARNESS

- 1100 ERGO-BP
- 1100 ERGO iPlus
- Any SpanSet harness will suit this application

2 CONNECTOR

- Spotter/stand-by person connects to tripod via a 3201 Retracting Lanyard.
- Spotter/stand-by person connects to tripod via a SVLB-2 Saverline 2 metre Fall Arrest Block.
- Spotter/stand-by person connects to tripod via a 3053-GP General Purpose Energy Absorbing Lanyard.
- Spotter/stand-by person connects to tripod via a Saverline Self Retracting Lifeline.

2 CONNECTOR

- For operator climbing down ladder.
- Device is a type 3/3 way fall arrest device with rescue only winch. For e.g. SVLRB-15 + bracket (SVLRB-15-BRACKET) required.
- Saverline Self Retracting Lifeline Rescue (SRLR) + bracket required.

3 ANCHOR

- Tripod is the TRIPOD-HD and comes with x1 tripod bracket (TRIPOD-HD-BRACKET-3) to fit x1 device.

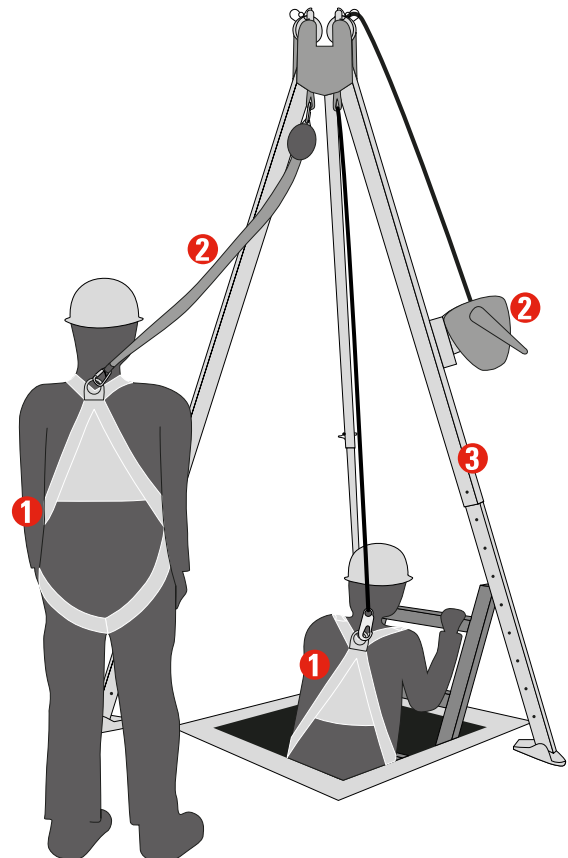

NOTE: SKETCHES ARE NOT TO SCALE AND ARE A SALES GUIDE ONLY. THIS GUIDE DOES NOT REPLACE WORKING SAFELY AT HEIGHTS TRAINING. FOR PRODUCT SPECIFICATIONS REFER TO PAGES 12-19.

Working with Tripods - Setup 2

Primary winch device and secondary fall arrest/rescue device. Set up when operator is required to enter a confined space via a winch positioning device and have a safety fall arrest back up device.

1 HARNESS

- 1100 ERGO-BP (4006-0 Spreader Bar also used as required).
- 1100 ERGO iPlus (4006-0 Spreader Bar also used as required).

NOTE: Any SpanSet harness will suit this application, except for the 1100 TRADIE.

2 CONNECTOR

- Spotter/stand-by person connects to tripod via a 3201 Retracting Lanyard.
- Spotter/stand-by person connects to tripod via a SVLB-2 Saverline 2 metre Fall Arrest Block.
- Spotter/stand-by person connects to tripod via a 3053-GP General Purpose Energy Absorbing Lanyard.
- Spotter/stand-by person connects to tripod via a Saverline Self Retracting Lifeline (SRL).

2 CONNECTOR

- Safety backup device for operator being winched down.
- Device is a type 3/3 way fall arrest device with rescue only winch. For e.g. SVLRB-15 + bracket (SVLRB-15-BRACKET) required.
- Saverline Self Retracting Lifeline Rescue (SRLR) + bracket required.

3 ANCHOR

- Winch device to winch operator down.
- Positioning winch is SVLWB-20 (not a fall arrest device) and is used to raise and lower personnel/material. Integrated bracket fits to required second tripod bracket (TRIPOD-HD-BRACKET-3).

3 ANCHOR

- Tripod is the TRIPOD-HD and comes with x1 tripod bracket (TRIPOD-HD-BRACKET-3) to fit x1 device.

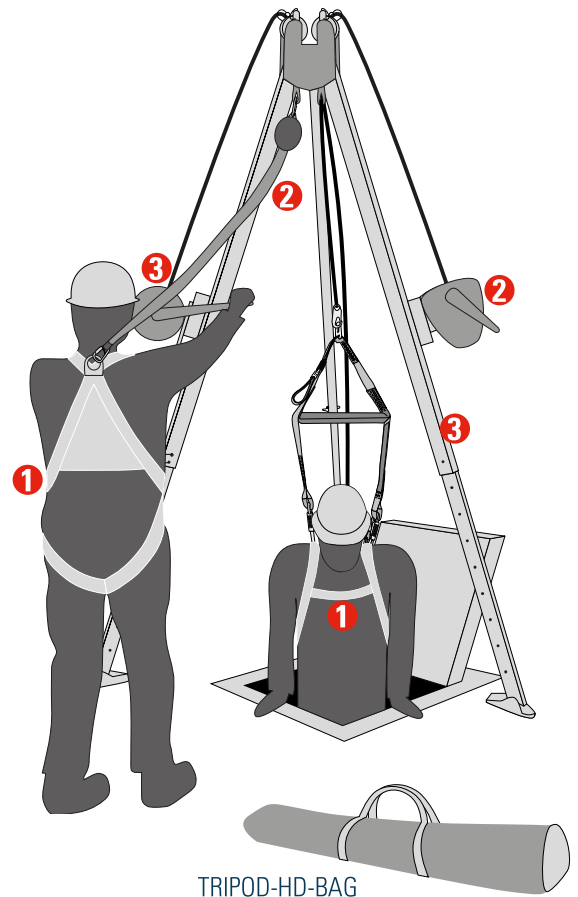

TRIPOD-HD-BAG

NOTE: SKETCHES ARE NOT TO SCALE AND ARE A SALES GUIDE ONLY. THIS GUIDE DOES NOT REPLACE WORKING SAFELY AT HEIGHTS TRAINING. FOR PRODUCT SPECIFICATIONS REFER TO PAGES 12-19.

Working with Tripods - Setup 3

Primary pulley device and secondary fall arrest/rescue device. Set up when operator is required to enter a confined space via a pulley positioning device and have a safety fall arrest back up device.

1 HARNESS

- 1100 ERGO-BP (4006-0 Spreader Bar also used as required).
- 1100 ERGO iPlus (4006-0 Spreader Bar also used as required).

NOTE: Any SpanSet harness will suit this application, except for the 1100 TRADIE.

2 CONNECTOR

- Spotter/stand-by person connects to tripod via a 3201 Retracting Lanyard.
- Spotter/stand-by person connects to tripod via a SVLB-2 Saverline 2 metre Fall Arrest Block.
- Spotter/stand-by person connects to tripod via a 3053-GP General Purpose Energy Absorbing Lanyard.
- Spotter/stand-by person connects to tripod via a Saverline Self Retracting Lifeline (SRL).

2 CONNECTOR

- Safety backup device for operator being winched down.
- Device is a type 3/3 way fall arrest device with rescue only winch. For e.g. SVLRB-15 + bracket (SVLRB-15-BRACKET) required.
- Saverline Self Retracting Lifeline Rescue (SRLR) + bracket required.

3 ANCHOR

- Pulley System to lower operator down.
- Positioning pulley device is 4000-0 (not a fall arrest device), used to raise and lower personnel and material.

3 ANCHOR

- Tripod is the TRIPOD-HD and comes with x1 tripod bracket (TRIPOD-HD-BRACKET-3) to fit x1 device.

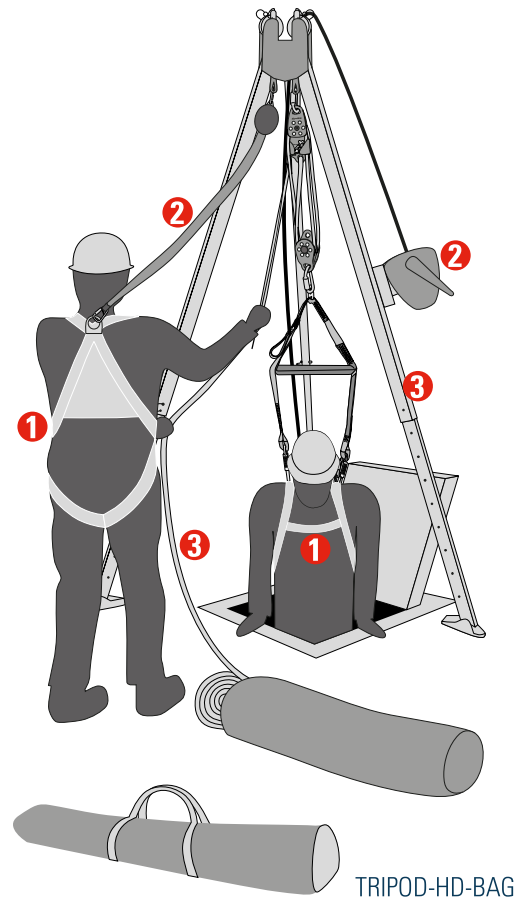

NOTE: SPANSET® IS NOT TO BE USED FOR THE PURPOSES OF LIFE SUPPORT. THE USER MUST TAKE THE NECESSARY PRECAUTIONS TO ENSURE THE SAFETY OF THE OPERATOR. FOR MORE INFORMATION, PLEASE REFER TO THE USER MANUAL.

1 2 3

Bucket of Safety Roofer's Kit

CODE: 6500



Kit contains:

- x1 1100 Tradie/Spectre full body harness.
- x1 3108SA anchorage line and rope adjuster with energy absorber.
- x1 K2 Karabiner.
- x1 3506-BS Black Snake 2 tonne 1 metre anchor attachment sling.
- x1 10 litre storage bucket.

Spectre Energy Absorbing Safety Kit 1 2 3

CODE: 6001SA-SPECTRE-0



Kit contains:

- x1 1100 Tradie/Spectre full body harness.
- x1 3108SA anchorage line and rope adjuster with energy absorber.
- x1 3506 Spectre anchor attachment sling.
- x1 K2 Karabiner.
- x1 Backpack kit bag.

Entry and Egress Pulley System

CODE: 4000-0



- 4:1 mechanical advantage.
- Locking, spring loaded, toothed cam.
- Self operated or by a second person.
- Kit contains: x1 anchor sling, x2 karabiners, x1 ascender/rope grab and x1 kit bag.

Gotcha™ Original Rescue Kit

CODE: GOTCHA-KIT-0



Kit contains:

- x1 Upper pulley.
- x1 Lower pulley.
- x1 Gotcha™ Frog.
- x1 Attachment pole.
- x1 Rope controller.
- Rescue rope.
- x1 Rope Grabba (for Inertia Reels).
- x1 Attachment sling.
- x2 Karabiners.
- x1 Gear bag.

1 2

1150 Elevated Work Platform Harness

CODE: 1150-EWP



- Full body fall arrest harness for elevated work platforms.
- 1.8m energy absorbing lanyard permanently attached to rear.
- Front fall arrest loops.
- Adjustable leg, shoulder and chest straps.
- Hi Vis webbing.
- Breathable mesh panel at rear.

1100 Tradie Full Body Fall Arrest Harness 1

CODE: 1100-TRADIE



- Rear fall arrest D ring.
- Front fall arrest loops.
- Fully adjustable shoulder and leg straps with carbon steel buckles.
- Hi Vis webbing.
- Breathable mesh panel at rear.

1 1100 ERGO Full Body Fall Arrest Harness

CODE: 1100 ERGO-BP



- Front and rear fall arrest D rings.
- Confined space attachment loops.
- Adjustable leg, shoulder and chest straps.
- Suspension trauma relief straps.
- Hi Vis webbing.
- Breathable mesh panel at rear.

1104 ERGO Full Body Fall Arrest Harness

CODE: 1104 ERGO-BP



- Front and rear fall arrest D rings.
- Rear extension strap.
- Confined space attachment loops.
- Adjustable leg, shoulder and chest straps.
- Suspension trauma relief straps.
- Hi Vis webbing.
- Breathable mesh panel at rear.

1 1107 ERGO Full Body Fall Arrest Harness

CODE: 1107 ERGO-0



- Front and rear fall arrest D rings.
- Padded waist belt with side D's for pole strap use.
- Rear extension strap.
- Confined space attachment loops.
- Adjustable leg, shoulder and chest straps.
- Suspension trauma relief straps.



1300 ERGO Full Body Fall Arrest Harness

CODE: 1300 ERGO-0



- Front and rear fall arrest D rings.
- Waist strap and side D's for pole strap use.
- Confined space attachment loops.
- Adjustable leg, shoulder and chest straps.
- Suspension trauma relief straps.
- Breathable mesh panel at rear.



1 1500 ERGO Tower Worker Harness

CODE: 1500 ERGO-0



- Full body harness.
- Rear fall arrest D ring.
- Front fall arrest loops.
- Padded waist band and side D rings for pole strap use.
- Padded lower buttock auxiliary band with O rings for pole strap use.
- Confined space attachment loops.
- Suspension trauma relief straps.



1800 ERGO Full Body Fall Arrest Harness

CODE: 1800 ERGO-0



- Rear fall arrest D ring.
- Front fall arrest and abseil wide mouth D rings.
- Padded waist band and side D rings for pole strap use.
- Reinforced gear loops.
- Elasticised rear leg droppers.
- Quick release shoulder buckle opening.
- Adjustable straps.



1 1100 ERGO Lite Full Body Fall Arrest Harness

CODE: 1100-ERGO-LITE



- Front and rear fall arrest Aluminium D rings.
- Confined space attachment loops.
- Green light indicator Aluminium quick connect buckles.
- Adjustable leg, shoulder and chest straps.
- Suspension trauma relief straps.
- Breathable mesh panel at rear.

1100 ERGO iPlus Premium Full Body Harness

CODE: 1100-ERGO-IPLUS



- iWeb™ inspection-ready, water and oil resistant Xtreme Guard webbing.
- Front and rear fall arrest Aluminium D rings.
- Confined space attachment loops.
- Green light indicator Aluminium quick connect buckles.
- Fully padded adjustable leg and shoulder straps.
- Suspension trauma relief straps.

1 1100 HotWorks Fall Arrest Harness

CODE: 1100 HOTWORKS



- Full body fall arrest harness.
- Heat resistant Heracron/ Meta Aramid webbing.
- Front and rear fall arrest D rings.
- Confined space attachment loops.
- Fully adjustable leg and shoulder straps.

1107 HotWorks Fall Arrest Harness

CODE: 1107 HOTWORKS



- Full body harness.
- Heat resistant Heracron/ Meta Aramid webbing.
- Front and rear fall arrest D rings.
- Padded waist belt with side D rings for pole strap use.
- Confined space attachment loops.
- Heat resistant padded leg and waist straps.

1 1300 HotWorks Fall Arrest Harness

CODE: 1300 HOTWORKS



- Full body fall arrest harness.
- Heat resistant Heracron/ Meta Aramid webbing.
- Front and rear fall arrest D rings.
- Waist belt with side D rings for pole strap use.
- Confined space attachment loops.
- Fully adjustable leg and shoulder straps.

HotWorks Energy Absorbing Twin Leg Lanyard

CODE: 3058 HotWorks



- 1.8m twin leg energy absorbing lanyard.
- Alloy steel snap hook at energy absorber end and alloy steel double action scaffold hooks at free ends.
- Heat resistant Heracron/ Meta Aramid webbing.
- Heat resistant protective energy pack cover.

2 Energy Absorbing Retracting Lanyard

CODE: 3201-0x2.5



- Lightweight 2.5 metre retracting lanyard.
 - Includes triple action karabiners and an integral energy absorber.
 - Ideal for light duty applications
- Static Lines, etc.
- 100kg load limit.

General Purpose Energy Absorbing Lanyard

CODE: 3053-GP



- 1.8 metre energy absorbing lanyard minimises forces endured by an operator in the event of a fall from height.
- Alloy steel snap hook at tear web energy absorber end and alloy steel snap hook at free end.

2 Energy Absorbing Lanyard with Scaffold Hook

CODE: 3055 SCAFF



- 1.8 metre long single leg webbing lanyard.
- Alloy steel snap hook at tear web energy absorber end and alloy steel double action scaffold hook at free end.

Energy Absorbing Twin Leg Access Lanyard

CODE: 3058 ACCESS



- 1.8 metre long twin leg webbing lanyard.
- Alloy steel snap hook at tear web energy absorber end and alloy steel double action scaffold hooks at free ends.

2 ERGO Twin Leg Elasticated Lanyard

CODE: 3058E-0x1.8



- 1.8 metre twin leg elasticated webbing lanyard.
- Alloy steel snap hook at tear web energy absorber end and alloy steel double action scaffold hooks at free ends.



2 ERGOplus Twin Leg Elasticated Lanyard

CODE: 3058E-ERGOplus



- 1.8 metre twin leg elasticated webbing lanyard.
- Abrasion resistant webbing.
- Aluminium snap hook at tear web energy absorber end and aluminium double action scaffold hooks at free ends.
- 140kg rated.



2 HotWorks Lanyard with Scaffold Hook

CODE: 3055 HotWorks



- 1.8 metre energy absorbing lanyard with alloy steel snap hook at energy absorber end and alloy steel double action scaffold hook at free end.
- Heat resistant Heracron/Meta Aramid webbing.
- Heat resistant protective energy pack cover.



HotWorks Energy Absorbing Lanyard

CODE: 3053 HotWorks



- 1.8 metre energy absorbing lanyard with alloy steel snap hooks at each end.
- Heat resistant Heracron/Meta Aramid webbing.
- Heat resistant protective energy pack cover.



2 Saverline 2 Metre Fall Arrest Block

CODE: SVLB-2



- Technora® webbing lifeline with tear away webbing fall indicator, internal braking mechanism and triple action karabiner.
- 2.3 metre effective length.
- 150kg load limit.
- Weighs 1.4kg.

Saverline 3 Metre Fall Arrest Block

CODE: SVLB-3



- Technora® webbing lifeline with tear away webbing fall indicator, internal braking mechanism and triple action karabiner.
- 3.6 metre effective length.
- 150kg load limit.
- Weighs 1.8kg.

2 Saverline - SRLR STU A S 24 STA

CODE: 2002381



- HRA 24.
- Aluminium housed fall arrest block with 24 metre galvanised steel cable lifeline and steel triple action anchor karabiner.
- For rescue only.
- 136kg load limit; weighs 16kg.
- Bracket (XTIN2376) required to fit to Xtirpa and Tripod.

Saverline - SRL SDE A W 1.8 ADH

CODE: 2002361



- ACB 1.8.
- EWP SRL with max 3kN force back to EWP anchor.
- Aluminium housed fall arrest block with 1.8 metre polyester webbing lifeline and aluminium double action snap hook.
- Edge tested with WLL 136kg.
- Weighs 0.96kg.

2 Saverline - SRL STU A W 2 STA

CODE: 2002345



- HWB 2.
- Aluminium housed fall arrest block with 2 metre polyester webbing lifeline and steel triple action anchor karabiner.
- 136kg load limit.
- Weighs 0.8kg.
- Edge Tested.

Saverline - SRL STU P S 3 STA

CODE: 2002346



- HWPS 3.
- Plastic housed fall arrest block with 3 metre long galvanised steel cable lifeline and steel triple action anchor karabiner.
- 136kg load limit.
- Weighs 1.9kg.
- Edge tested.

2 Saverline - SRL STU P W 3.5 STA

CODE: 2002347



- HWPB 3.5.
- Plastic housed fall arrest block with 3.5 metre long polyester webbing lifeline and steel triple action anchor karabiner.
- 136kg load limit.
- Weighs 1.2kg.
- Edge tested.

Saverline - SRL STU P S 6 STA

CODE: 2002348



- HWPS 6.
- Plastic housed fall arrest block with 6 metre galvanised steel cable lifeline and steel triple action anchor karabiner.
- 136kg load limit.
- Weighs 2.5kg.
- Edge tested.



2 Saverline - SRL STU P W 7 STA

CODE: 2002349



- HWPB 7.
- Plastic housed fall arrest block.
- 7m polyester webbing lifeline.
- Comes with steel triple action anchor karabiner.
- 136kg load limit.
- Weighs 1.8kg.
- Edge tested.

2 Single Dynamic Self Retracting Lanyard

CODE: SVLB-DSL-STL, SVLB-DSL-ALU



- One small retracting lifeline with one energy absorbing pack.
- Retractable feature reduces fall distance and trip hazards.
- Suitable for continuous attachment.
- Rated to 140kg.
- Edge tested.

2 Double Dynamic Self Retracting Lanyard

CODE: SVLB-DSL2 -STL, SVLB-DSL2-ALU



- Combines two small retracting lifelines with one common energy absorbing pack.
- Retractable feature reduces fall distance and trip hazards.
- Suitable for continuous attachment.
- Rated to 140kg.
- Edge tested.

2 3 Way Fall Arrest Recovery Block

CODE: SVLRB-15



- 15 metre galvanised steel cable lifeline.
- Swivel karabiner fall indicator.
- 150kg load limit.
- Weighs 10.4kg.
- Connects to Xtirpa and Tripod with SVLRB-15-BRACKET.

2 Spreader Bar

CODE: 4006-0



- Lifts/lowers personnel in confined spaces.
- Stainless steel bar with 44mm webbing and x2 heavy duty snap hooks.
- Wrist restraint to aid in narrowing shoulders.

2 Energy Absorbing Anchorage Line

CODE: 3108SA-RP



- Horizontal anchorage lifeline with a permanently attached energy absorber.
- 15 metre Kernmantle rope.
- Type 1 rope adjuster.
- Double action snap hook.
- Other lengths are available upon request.

2 Tripod

CODE: TRIPOD-HD



- Aluminium with one piece cast head.
- Integrated twin pulleys.
- Additional auxiliary anchorage point.
- Fully adjustable legs.
- Comes with x1 device mount bracket (Tripod-HD-Bracket-3).
- 360kg WLL.

2 Material / Personnel Winch

CODE: SVLWB-20



- 20m galvanised steel cable.
- Wire guide rollers and spring loaded spool retention bar.
- 22:1 mechanical advantage.
- 150kg load limit.
- Weighs 14kg.
- Integrated bracket fits to Xtirpa and Tripod mounts.

*For personnel, the winch MUST be used in conjunction with a back up SRL.

3
K2 & K4 Crab Sets

CODES: K2-CRABSET & K4-CRABSET

K2 Crab Set

- Pack of x2 alloy steel oval screw gate karabiners with an opening of 15mm. 23kN strength rating.

K4 Crab Set

- Pack of x2 alloy steel D shape triple action gate karabiners with an opening of 19mm. 41kN strength rating.

Two Person Horizontal Safety Line

CODE: 3400-UK-0x18



- Rated for use by 2 people.
- 18m webbing lifeline.
- 20020 ratchet with Tension Force Indicator (TFI) supplied with two safety shackles.

3
Adjustable Pole Strap

CODE: 2700-RP



- 2.5 metre pole strap with adjuster and snap hooks at each end.
- Includes polyester webbing wear sleeve.
- Other lengths are available upon request.
- Use with any 1300, 1107, 1500, 1800 style harnesses.

HotWorks Adjustable Pole Strap

CODE: 2700-HW-0x2.5



- 2.5 metre pole strap with adjuster and snap hooks at each end.
- Heat resistant Heracron/Meta Aramid webbing.
- Suitable for pole, tower, access and climbing applications.
- Other lengths are available.
- Use with HotWorks 1300, 1107, 1600, 1800 harnesses.

3
Anchor Strap

CODE: 3501-BP



- Anchor strap for connection to a strong, solid, horizontal and permanent structure at one end, and a lanyard, restraint line or fall arrest device at the other end.
- Rated to 22kN in a choke configuration.
- Other lengths are available upon request.

HotWorks Anchor Strap

CODE: 3501-HW-0x2.0



- Heat resistant Heracron/Meta Aramid webbing Anchor Strap.
- Connects to a strong, solid, horizontal and permanent structure at one end, and a lanyard, restraint line or fall arrest device at the other end.
- Rated to 22kN in a choke configuration.
- Other lengths are available.

3
Black Snake Attachment Anchor Sling

CODE: 3506-BS-RP



- Strong 1 metre round attachment anchor sling.
- Minimum break strength of 7 tonnes.
- Other lengths are available upon request.

Metal and Timber Temporary Roof Anchor

CODE: FASTLINK



- Temporary one person roof anchor that can be installed onto a metal or tiled roof.
- Multi-directional height safety anchor designed to maximise energy absorption.
- Used when there is no permanent safety anchors.
- Complies with AS1891.4.

SpanSet® Xtirpa™ 610mm Davit, Mast & Base Kit

CODE: SPXT24



- Lightweight Davit with 610mm (24inch) reach.
- Easy and safe access to confined spaces.
- Works well on sites with multiple types of entry and minimises costs due to lack of duplication.
- WLL of 164kg.
- 10:1 safety factor.
- Devices not included.

SpanSet® Xtirpa™ 1219mm Davit, Mast & Base Kit

CODE: SPXT48



- Provides easy and safe access to confined spaces.
- 1219mm (48inch) reach.
- 16kN capacity.
- Working load limit of 164kg.
- 10:1 safety factor.
- Double pulley works well in twin rope access procedures.

SpanSet® Xtirpa™ Portable Manhole Guard

CODE: SPXT3



- Portable manhole guard has an integrated mast which when used in conjunction with a davit arm, transforms into a confined space fall protection and retrieval system.
- Provides access to underground chambers.
- Working load limit of 191kg.
- 10:1 safety factor.

SpanSet® Xtirpa™ Tow Bar Hitch Davit System

CODE: SPXT6



- Connects to most 50mm square vehicle receiver hitches.
- Adjustable screw pads for easy levelling.
- Connects to SPXTIN2210 Davit Arm.
- Working load limit of 164kg.
- 10:1 safety factor.
- Devices not included.

SpanSet® Xtirpa™ 2438mm Davit, Mast & Base Kit

CODE: SPXT96



- Davit is easily positioned from 775mm, 915mm and 1200mm.
- Provides easy and safe access to confined spaces.
- 2438mm (96inch) reach.
- 16kN capacity.
- Working load limit of 164kg.
- 10:1 safety factor.

SpanSet® Xtirpa™ 1219mm Counter Weight System

CODE: various codes contact SpanSet for details



- Provides multiple confined space access in same area where extra reach is required.
- Central unit where optional equipment can be added.
- 16kN capacity.
- Weight capacity of 164kg.



Head Office

SpanSet Australia Ltd
150 Old Bathurst Road
(PO Box 164)
Emu Plains NSW 2750

Phone: 02 4735 3955
Fax: 02 4735 3630

sales@spanset.com.au
www.spanset.com.au

Western Australia Office

Unit 1, 50 Tulloch Way,
Canning Vale WA 6155

Phone: 08 9455 7404
Fax: 08 9455 3477
